

TH-9800 User Manual

Thank you very much for choosing the **777** TH-9800 quad band mobile transceiver. The TH-9800 provides you with a reliable, clear and efficient communications service which is enhanced by an ergonomic design and intuitive user controls. Inherently reliable, you can depend on your TH-9800 no matter where you are in the harsh environment.

The TH-9800 is cost-effective, multi-functional and will meet all of your HF/VHF/UHF band communication needs no matter what the situation.

For a full explanation of the many features, functions and the care free maintenance of your new mobile please take the time to read the user manual enclosed with your transceiver.

CONTENTS	
User Safety Information	01
Package includes	01
Main Features	02
Initial Installation	03
Mobile Installation	03
Installation methods	03
Mounting bracket installation	04
Separation cable connection	04
DC Power Cable Connection	05
Fixed Station Operation	06
Replacing Fuses	07
Antenna Connection	08
Accessories Connections	09
External Speaker	09
Microphone	10
Getting Acquainted	11
Front Panel Operation	11

Display	14
Rear Panel	15
Microphone	15
Basic Operation	17
Switching the power on/off	17
Adjusting the volume	17
Adjusting the squelch level	17
Selecting the operating band	17
Selecting the frequency band	18
Selecting desired frequency	18
Receiving	19
Transmitting	19
Selecting the power output level	19
Memory Operation	20
Memory Channel Storage	20
Storing independent transmit frequencies ("Odd Splits")	21
Memory Recall	21
Memory Tuning	21

Deleting Memories	22
HOME Channel Memory	22
Hyper Memory Channel	22
Memory Only Mode	23
Some Advanced Features	24
Repeater Operation	24
CTCSS Tone / DCS Code Operation	25
DCS Code Inversion	27
Tone Search Scanning	27
User-defined CTCSS Tone / DCS Code Operation	28
Various Scanning	28
VFO Scanning	29
Memory Scanning	29
Set a "Skipped" Channel During Memory Scan Operation	30
Preferential Memory Scanning	30
Programmable Memory Scan	31
Priority Channel Scanning (Dual Watch)	31
DTMF Signaling Operation	32

2 Tone & 5 Tone Signaling Operation	34
Auto Range Transponder System (ARTS) Operation	34
Cross-band Repeater Operation	35
Microphone Key Assignments	36
Menu Operation	38
Factory Reset Operation	47
Simple Trouble Shooting	48
Specifications	49

User Safety Information

- Do not attempt to configure your transceiver while driving.
- This transceiver is designed for a 13.8V DC power supply. Do not use a 24V battery to power on the transceiver.
- Please keep it away from inferential devices (Such as TV s, generators, etc.)
- Do not expose the transceiver to long periods of direct sunlight or place it close to heating appliances.
- If an abnormal odour or smoke is detected coming from the transceiver, turn off the power immediately and contact your dealer.
- Do not transmit with high power for extended periods or the transceiver may overheat.

Package includes:

- Radio unit x 1
- Keypad DTMF microphone x 1
- Radio body mounting bracket x 1
- DC power cable with fuse holder x 1
- Front controller separation cable x 1
- Front controller mounting bracket x 1
- Screw packs x 1
- Protection fuses x 1
- User manual x 1

Main Features

- Cover 29 / 50 / 144 / 430 MHz four transmitting bands
- Wide band AM receiving and FM receiving for 26-33MHz, 47-54MHz, 108-180MHz, 320-512MHz, 750-950MHz (except cell phone).
- Independent controls for each left and right band
- V+V, U+U, V+U simultaneous receive capability
- Built-in V+U cross-band repeater and full duplex capability
- 800 memory channels and independent setting per channel
- 50W of high power output for VHF band and 40W for UHF band
- Standard 50 groups of CTCSS tone and 104 groups of DCS code
- User-defined CTCSS tone & DCS code capability
- DTMF / 2-Tone / 5-Tone for selective calling
- Voice compander and encryption scramble
- Automatic Repeater Shift (ARS)
- Detachable front controller and remote mounting capability
- Ultra-size LCD dual display screen
- User-programmable microphone keys

Initial Installation

Mobile Installation

To install the transceiver select a safe and convenient location inside your vehicle that minimizes danger to your passengers and yourself while the vehicle is in motion. Consider installing the unit at an appropriate position so that knees or legs will not strike it during sudden braking of your vehicle. Try to pick a well ventilated location that is shielded from direct sunlight.

Installation methods

1 – Single Body Installation

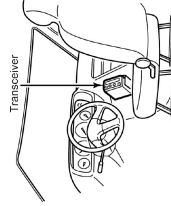

The supplied mounting bracket can be used for the main unit installation.

2 – Remote Control Installation

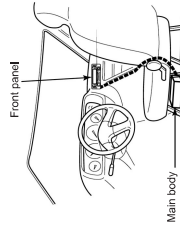

The supplied remote controller mounting bracket and separation cable can be used for installation.

Mounting bracket installation

1. Drill 4 holes where the mounting bracket is to be installed.
2. Insert the supplied screws, nuts and washers through the mounting bracket and tighten.
3. Adjust the angle for your suitable position.

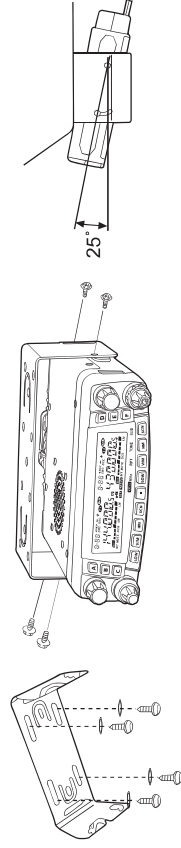

Separation cable connection

A separation cable (4.5m; 14.8 ft) is supplied with the TH-9800.

Connect the controller and the main unit using with the separation cable as follows.

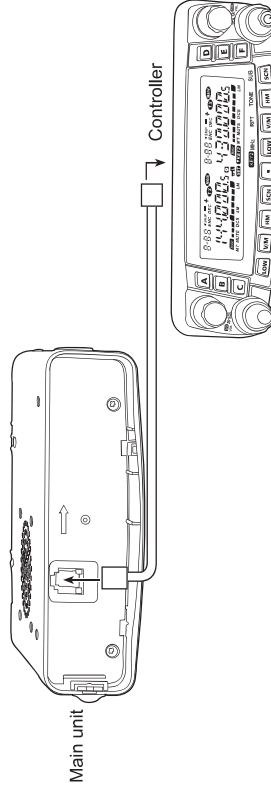

DC Power Cable Connection

Note: Locate the power input connector as close to the transceiver as possible.

The vehicle battery must have a nominal rating of 12V. Never connect the transceiver to a 24V battery. Be sure to use a 12V vehicle battery that has sufficient current capacity. If the current to the transceiver is insufficient the display may darken during transmission or transmitting output power may drop excessively.

1. Route the DC power cable supplied with the transceiver directly to the vehicle's battery terminals using the shortest path from the transceiver. We suggest you do not use the cigarette lighter socket as some cigarette lighter sockets introduce an unacceptable voltage drop. The entire length of the cable must be dressed so it is isolated from heat, moisture and the engine secondary (high voltage) ignition system/cables.
2. After installing the cable, in order to avoid the risk of damp, please use heat-resistant tape to tie together with the fuse box. Do not forget to reinforce the whole cable.
3. Confirm the correct polarity of the connections, then attach the power cable to the battery terminals: Red connects to the positive (+) terminal and black connects to the negative (-) terminal.
4. Reconnect any wiring removed from the negative terminal.
5. Connect the DC power cable to the transceiver's power supply connector. Press the connectors firmly together until the locking tab clicks.

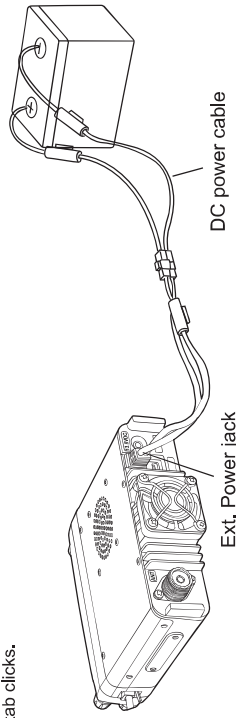

Fixed Station Operation

In order to use this transceiver for fixed station operation you will need a separate 13.8V DC power supply (not included). Please contact your local dealer about it.

The recommended current capacity of your power supply is 12A.

1. Connect the DC power cable to the regulated DC power supply and ensure that the polarities are correct. (Red: positive; Black: Negative).
Do not directly the transceiver to an AC outlet.
Use the supplied DC power cable to connect the transceiver to a regulated power supply.
Do not substitute a cable with smaller gauge wires.
2. Connect the transceiver's DC power connector to the connector on the DC power cable.
3. Press the connectors firmly together until the locking tab clicks.

Note:

- Before connecting the DC power to the transceiver be sure to switch the transceiver and the DC power supply OFF.
- Do not plug the DC power supply into an AC outlet until you make all connections.

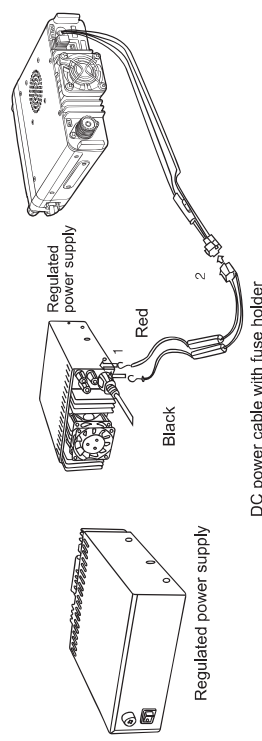

DC power cable with fuse holder

Replacing Fuses

If the fuse blows, determine the cause then correct the problem. After the problem is resolved replace the fuse. If newly installed fuses continue to blow, disconnect the power cable and contact your local dealer for assistance.

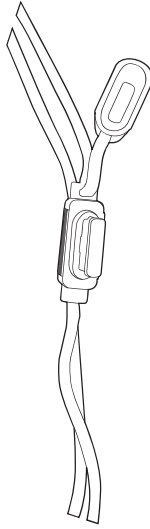

Fuse Location	Fuse Current Rating
Transceiver	15A
Supplied Accessory DC power cable	20A

Only use fuses of the specified type and rating otherwise the transceiver could be damaged.

Note: If you use the transceiver for a long period when the vehicle battery is not fully charged or when the engine is OFF, the battery may become discharged and will not have sufficient reserves to start the vehicle. Avoid using the transceiver in these conditions.

Antenna Connection

Before operating install an efficient well-tuned antenna. The success of your installation will depend largely on the type of antenna and its correct installation. The transceiver can give excellent results if the antenna system and its installation are given careful attention.

Use a 50 Ω impedance antenna and low-loss coaxial feed-line that has a characteristic impedance of 50 Ω , to match the transceiver input impedance. Coupling the antenna to the transceiver via feed-lines having a impedance other than 50 Ω reduces the efficiency of the antenna system and can cause interference to nearby broadcast TV receivers, radio receivers and other electronic equipment.

Note: Transmitting without first connecting an antenna or other matched load may damage the transceiver. Always connect the antenna to the transceiver before transmitting. All fixed stations should be equipped with a lightning arrester to reduce the risk of fire, electric shock and transceiver damage.

Accessories Connections

External Speaker

If you plan to use an external speaker, choose a speaker with an impedance of $8\ \Omega$. The external speaker jack accepts a 3.5mm mono (2-conductor) plug.

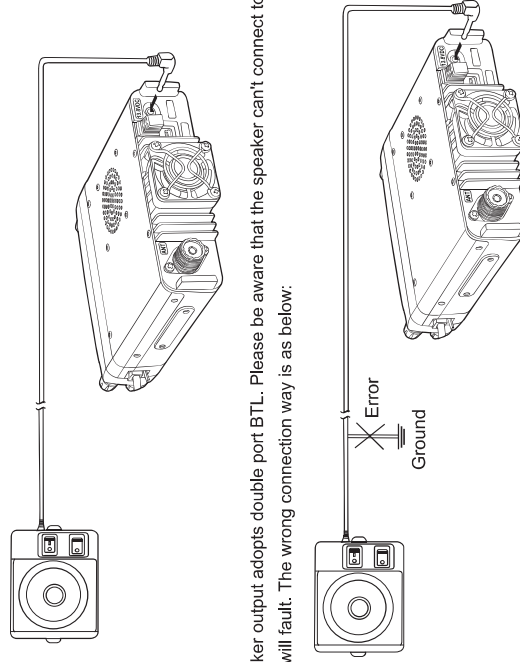

Note: External speaker output adopts double port BTL. Please be aware that the speaker can't connect to the ground otherwise the speaker will fault. The wrong connection way is as below:

Microphone

For voice communications connect a microphone equipped with an 8-pin modular plug into the modular socket on the side of the main unit. Press firmly on the plug until the locking tab clicks. Attach the supplied microphone hanger in an appropriate location using the screws included in the screw set.

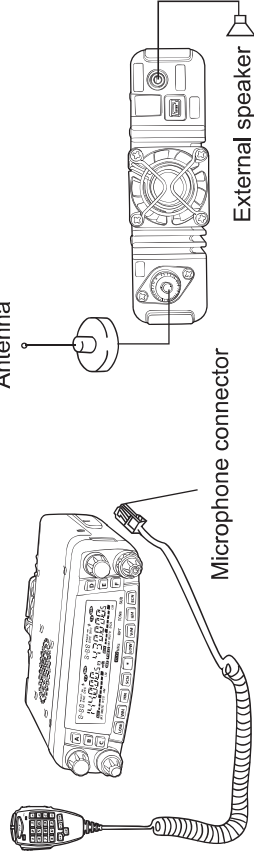

Getting Acquainted Front Panel Operation

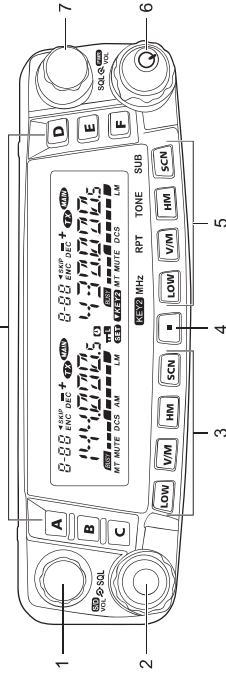

NO.	KEY	FUNCTION
1	LEFT DIAL	<ol style="list-style-type: none"> 1. Tuning dial for the "left" band. 2. Short press the knob to set the "left" band as the "Main" band. 3. Enable rapid tuning (in 1 MHz steps) when the "left" band is set to be the "Main" band in VFO mode. 4. Press and hold in this knob for 1/2 second to toggle the operating band on the left side as follows: 144 MHz -> 350 MHz -> 430 MHz -> 850 MHz -> 29 MHz -> 50 MHz...
2	LEFT VOL/SQ	<ol style="list-style-type: none"> 1. The outer VOL (Volume) control adjusts the "left" receiver speaker audio level. 2. Short press the knob to switch single receive mode "on" and "off". 3. Press and hold this knob for 1/2 second to switch the front panel keys LOCK feature "on" and "off". 4. The inner SQL (Squelch) control adjusts the "left" receiver background noise.
3	LEFT [LOW]	<ol style="list-style-type: none"> 1. Short press the key to switch power output level of the "left" band (LOW-MID2-MID1-HIGH). 2. Press and hold in this key for 1/2 second to switch memory display mode between "Frequency" and "Channel Tag" when the "left" band is set to the Memory mode or Home Channel.

3	<p>LEFT [V/M]</p> <ol style="list-style-type: none"> 1. Short press the key to switch frequency control for the "left" band between the VFO and Memory mode. 2. Press and hold in this key for 1/2 second to shift to the "Memory Tuning" feature when the "left" band is set to the Memory mode. <p>LEFT [HM]</p> <ol style="list-style-type: none"> 1. Short press the key to recall a favorite "HOME" frequency memory. 2. Press and hold in this key for 1/2 second to activate Priority Channel Scanning under VFO or MR mode. <p>LEFT [SCN]</p> <ol style="list-style-type: none"> 1. Short press the key to activate the Scanner on the "left" band. 2. Press and hold in this key for 1/2 second to set up the Scan Skip List or Preferential Scan List under MR mode. 	<p>LEFT [V/M]</p> <ol style="list-style-type: none"> 1. Short press the key for 1/2 second to enter the Menu mode. 2. Press and hold in this key for 1/2 second to transfer the contents of the Main band VFO into a Memory system.
4	<p>[SET]</p> <ol style="list-style-type: none"> 1. Short press the key to switch power output level of the "right" band (LOW-MID2-MID1-HIGH). 2. Press and hold in this key for 1/2 second to switch memory display mode between "Frequency" and "Channel Tag" when the "right" band is set to the Memory mode or Home Channel. 	<p>RIGHT [V/M]</p> <ol style="list-style-type: none"> 1. Short press the key to allow tuning in 1 MHz steps on the "Main" band VFO. 2. Press and hold in this key for 1/2 second to allow tuning in 10 MHz steps on the "Main" band VFO.
5	<p>RIGHT [V/M]</p> <ol style="list-style-type: none"> 1. Short press the key to switch frequency control for the "right" band between the VFO and Memory mode. 2. Press and hold in this key for 1/2 second to shift to the "Memory Tuning" feature when the "right" band is set to the Memory mode. <p>RIGHT [RPT]</p> <ol style="list-style-type: none"> 1. Short press the key to change the frequency shift direction: RPT - (minus shift), RPT + (plus shift), or RPT OFF (simplex). 2. Press and hold in this key for 1/2 second to reverse TX and RX frequencies on the "Main" band during split-frequency operation. 	

	<p>RIGHT [HM] (Default)</p> <p>1. Short press the key to recall a favorite "HOME" frequency memory. 2. Press and hold in this key for 1/2 second to activate Priority Channel Scanning under VFO or MR mode.</p>
5	<p>RIGHT [TONE] (Key Mode 2)</p> <p>Short press the key to change the Tone Squelch mode: ENC (CTCSS Encoder), ENC DEC (CTCSS Encoder & Decoder) or DCS operation.</p> <p>RIGHT [SCN] (Default)</p> <p>1. Short press the key to activate the Scanner on the "right" band. 2. Press and hold in this key for 1/2 second to set up the Scan Skip List or Preferential Scan List under MR mode.</p> <p>RIGHT [SUB] (Key Mode 2)</p> <p>Short press the key to make the next key you press act on the "Sub band". (The "MAIN" icon will blink on the "Sub band")</p>
6	<p>RIGHT VOL/SOL</p> <p>1. The outer VOL (Volume) control adjusts the "right" receiver speaker audio level. 2. Press and hold this knob for 1/2 second to turn the radio "on" and "off". 3. The inner SQL (Squelch) control adjusts the "right" receiver background noise.</p>
7	<p>RIGHT DIAL</p> <p>1. Tuning dial for the "right" band. 2. Short press the knob to set the right band as the "Main" band. 3. Enable rapid tuning (in 1 MHz steps) when the "right" band is set to be the Main band in VFO mode. 4. Press and hold in this knob for 1/2 second to toggle the operating band between 144 MHz and 430 MHz on the right side.</p>
8	<p>Hyper Memory Keys [A] - [F]</p> <p>1. Press and hold in one of these buttons for 2 seconds to store the current configuration of the radio into a special "Hyper" memory bank. 2. Short press the appropriate button to recall the desired "Hyper" memory.</p>

Display

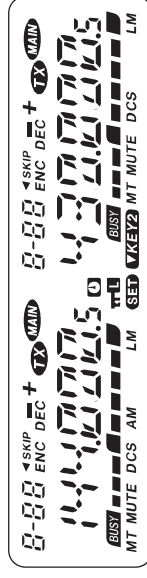

NO.	Icon	FUNCTION
1	8-8.8	Memory Channel Number
2	◀	Preferential Memory Channel
3	SKIP	Skip Memory Channel
4	—	Minus Shift
5	+	Plus Shift
6	—+	Odd Splits
7	ENC	CTCSS Encoder On
8	DEC	CTCSS Decoder On
9	TX	Transmitting
10	MAIN	"Main" Band
11	BUSY	Busy Channel (or Squelch Off)

NO.	Icon	FUNCTION
12	MT	Memory Tune Mode
13	MUTE	Audio Mute Activate
14	DCS	DCS On
15	AM	AM Reception
16	L	Low Power Output
17	M	Middle Power Output
18	U	Automatic Power-Off
19	TL	Keypad/Dial Lock
20	SET	Menu Set
21	KEYS	Key Mode 2 active

Rear Panel



NO.	Port	FUNCTION
1	ANT	Connection for 50Ω antenna.
2	EXT SP	Terminal for optional external speaker.
3	DATA	PC programming data port.

Microphone

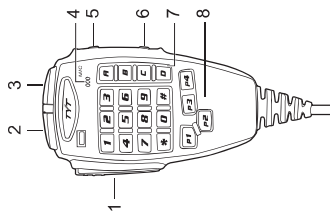

NO.	Port	FUNCTION
1	PTT	Press the key to transmit.
2	DWN	Decrease channel number or setting value.
3	UP	Increase channel number or setting value.
4	MIC	Speak here during transmission.
5	LOCK	Locks out the microphone buttons except key 0 - 9 and PTT.
6	LAMP	Illuminates the microphone keypad.
7	Number Key	Input channel number or DTMF dial out etc.
8	Programmable Keys	User-defined functions Keys. Default:
		P1 : switch the "Main" band between the left and right display.
		P2 : switch the frequency control for the "Main" band between VFO and Memory mode.
		P3 : press repeatedly to select the CTCSS or DCS mode on the "Main" band. P4 : press repeatedly to select TX power output level on the "Main" band.

Basic Operation

Switching the power on/off

To turn the mobile power ON press and hold the **RIGHT VOL/SQ** knob for 1/2 second.

To turn the mobile power OFF press and hold the **RIGHT VOL/SQ** knob for 1/2 second again.

Adjusting the volume

Turn the outer **VOL** control clockwise to increase the receiver speaker audio level and counter clockwise to decrease it.

Note:

1. Volume can be adjusted more accurately during communication.
2. The audio volume level is set independently by the **LEFT** and **RIGHT VOL** control.

Adjusting the squelch level

Turn the inner **SQ** control clockwise to increase the receiver background noise and counter clockwise to decrease it.

Note:

The squelch level is also set independently by the **LEFT** and **RIGHT SQ** control.

Selecting the operating band

In the factory default configuration, the TH-9800 operates in the "Dual Receive" mode.

During Dual Receive operation, the "Main" band frequency (on which transmission is possible) will be indicated by the "  " icon.

Short press the microphone's **[P1]** key or press the **DIAL** knob for the "left" or "right" side, the "  " icon will light up alternative sides of the display as you switch "Main" bands from the "left" side to the "right" side, and vice-versa.

Note:

Short press the **LEFT VOL/SQ** knob to switch the single receive mode ON and OFF. When it is set ON, the working vol-

lage will be shown on the "sub" band, the "  " icon will appear on the display, and **LEFT [LOW]**, **[V/M]**, **[HM]**, **[SCN]**, **RIGHT [MHz]**, **[RPT]**, **[TONE]** keys will be valid for the operating band.

Selecting the frequency band

Press and hold in **LEFT DIAL** knob for 1/2 second to toggle the operating band on the "left" band.

144 MHz -> 350 MHz -> 430 MHz -> 850 MHz -> 29 MHz -> 50 MHz..

Press and hold in **RIGHT DIAL** knob for 1/2 second to toggle the operating band between 144 MHz and 430 MHz on the right side.

Note:

TH-9800 can operate either in a V+V or U+V working mode, if needed.



VHF-VHF (V-V) Operation



UHF-JHF (U-U) Operation

Selecting desired frequency

1. Turning Dial

Under VFO mode, rotating the **DIAL** knob allows tuning in the pre-programmed steps established for the current operating band. Clockwise rotation will increase the operating frequency while counter-clockwise rotation will lower it.

On the Main band frequency, short press the **DIAL** knob then rotate it, to change the Main band frequency steps to 1 MHz step. This feature is useful for making rapid frequency excursions over the wide tuning range of the TH-9800.

2. Directly Frequency Entry by the Microphone s keypad

The keypad of the DTMF microphone may be used for directly entry of the Main band operating frequency.

To enter a frequency from the keypad, just press the numbered digits in the proper sequence. There is no decimal point key on the keypad, so if the frequency is below 100 MHz any required leading zeroes must be entered.

Example: To enter 29.025 MHz, press [2] -> [2] -> [9] -> [0] -> [0] -> [2] -> [5]
To enter 144.025 MHz, press [1] -> [4] -> [4] -> [0] -> [0] -> [2] -> [5]

Receiving

The **RSV** sign will appear whenever you receive a call on the channel you are on.

Note: The transceiver may fail to receive the signal if the squelch level is set high.

Transmitting

To transmit, hold the microphone about 2.5 - 5cm from your mouth, simply press the **PTT** switch on the microphone and speak in your normal speaking voice.

Note: Press and hold **PTT** switch, LED lights **ORANGE** and power intensity shown on the display indicates transmission is in progress.

Selecting the power output level

To change the power level, press the **[LOW]** key to select one of four power settings. There power levels will be stored, in memory registers, at the time of memory storage.

LOW	MID 2	MID 1	HIGH
5 W	10 W	20 W	50 W / UHF: 40 W

During transmission, the Bar Graph will deflect in the display, according to the power output selected.

Note:

You may change the power level on the "Main" band using the microphone's **[P4]** key.

Memory Operation

The TH-9800 provides 4 kinds of memory systems. These include:

1. 800 standard memory channels, numbered "001" through "800".
2. 5 pairs of band-edge memories labeled "L1/U1" through "L5/U5".
3. 6 Home channels which providing storage and quick recall of one prime frequency on each operating band.
4. 6 "Hyper-Memory" channels which can be recalled by **[A]** - **[F]** keys.

Memory channels storage

1. Select the desired frequency as well as CTCSS, DCS, repeater offset, power level in the operating VFO mode on the "Main" band.
2. Press and hold in the **[SET]** key for 1/2 second to start memory storage. A memory number will be blinking on the top line of display.
3. Use the "Main" band **DIAL** knob or the microphone's **[UP]** / **[DWN]** buttons to selected the desired memory channel for storage.
4. Press and hold in the **[SET]** key for 1/2 second again to add the channel alpha-numeric tag. Rotate the "Main" band **DIAL** to select the first character in the name you wish to store, short press the **DIAL** or the microphone's **[UP]** button to move on to the next character. The available for character includes digits "0 ~ 9", letters "A ~ Z" and symbols "., +, -, /, x".
5. Again short press the **DIAL** or the microphone's **[UP]** button to move on to the next character's slot. If you make a mistake, press microphone's **[DWN]** button to move back to the previous character's slot, then re-select the correct letter, number or symbol.
6. Repeat the above step to program the remaining letters, numbers, or symbols of the desired label. A total of six characters may be used in channel's tag.
7. When you have completed the creation of the tag, short press the **[SET]** key to save the tag and exit to normal operation.

Note:

If you don't want to attach a alpha name tag to the memory, short press the **[SET]** key directly after Step 3, to save the entry and exit to normal operation.

Storing independent transmit frequencies ("Odd Splits")

1. Store the receiving frequency as the steps already described.
2. Turn to the desired transmit frequency on the "Main" band, then press and hold in the **[SET]** key for 1/2 second.
3. Use the "Main" band **DIAL** knob or microphone's **[UP]** / **[DWN]** buttons to select the same memory channel number as used in Step 1 above.
4. Press and hold in the **PTT** switch, then short press **[SET]** while holding the **PTT** switch to save the entry and exit to normal operation. The "↔" icon will appear on the channel.

Note:

Whenever you recall a memory which contains independent-stored transmit and receive frequencies, the "↔" icon will appear in the display.

Memory Recall

1. While operating in the VFO mode, short press the **[V/M]** key to enter the Memory mode.
2. Rotate the **DIAL** knob or enter the microphone's key in the memory channel number to select the desired channel.

Note:

Memory channels on which you may have stored frequencies on the 29 MHz and 50 MHz two bands can not be recalled on the "right" band.

Memory Tuning

1. Select the desired memory channel under MR (Memory Recall) mode
2. Press and hold in the **[V/M]** key for 1/2 second; the "MT" icon will appear on the display.

21

3. Rotate the **DIAL** knob to turn to a new frequency. The synthesizer steps selected for VFO operation on the current band will be the steps used during Memory Tuning.

4. Short press **[V/M]** key again and exit Memory Tuning. The "MT" icon will disappear.

Deleting Memories

1. Short press **[V/M]** key to enter the Memory mode.
2. Press and hold in the **[SET]** key for 1/2 second, then rotate the "Main" band **DIAL** to select the memory channel to be selected. Note that memory channel #1 may not be deleted.
3. Short press the "Main" band **[SCN]** key to delete the channel selected. The display will revert to memory channel #1. Rotate the **DIAL** knob to the channel you just deleted, you will observe that it is invisible now.

HOME Channel Memory

The TH-9800 allows quick recall of a favorite operating frequency on each band, called HOME channel (one for each of the 6 operating bands).

1. Select the desired frequency as well as CTCSS, DCS, repeater offset, power level in the operating VFO mode on the "Main" band.
2. Press and hold in the **[SET]** key for 1/2 second to start memory storage. A memory number will be blinking on the top line of display.
3. Short press the "Main" **[HM]** key to store the VFO frequencies and other data in the special HOME channel register.
4. Repeat the steps above on the other operating bands.
5. To recall the HOME channel, just press the **[HM]** key while operating either in the VFO or MR mode.

Hyper Memory Channel

The TH-9800 allows you to store the total current configuration of the radio into a special "Hyper" memory bank, including operating frequency, CTCSS/DCS data, repeater shift, power level, scanning feature, menu setting...etc. for both the "left"

122

and "right" bands.

1. Set up the desired configuration for both the "left" and "right" bands.
2. Press and hold in the one of the Hyper Memory keys **[A]** ~ **[F]** for 2 seconds to store into the Hyper Memory channel which you wish to store that configuration.
3. Press the appropriate Hyper Memory Key **[A]** - **[F]** to recall the desired Hyper Memory channel. Please store the current configuration into Hyper Memory Channel before recalling the Hyper Memory Channel to prevent the current configuration lost.

Memory Only Mode

When you store the memory channels, you may place the radio in a "Memory Only" mode, whereby VFO operation is impossible. This may be particularly useful during public-service events where a number of operators may be using the radio for first time, and ultimate simplicity of channel selection is desired.

Procedure:

1. Turn the radio off.
2. Press and hold in the **LEFT [V/M]** while turning the radio on.
3. Rotate the **DIAL** knob to select the **(F-5 M-ONLY MODE)**, then short press the **[SET]** key to confirm. The radio will restart and enter Memory Only Mode.
4. To return to normal operation, repeat the above steps.

Some Advanced Features

Repeater Operation

The TH-9800 provides a convenient Automatic Repeater Shift feature, which causes the appropriate repeater shift to be automatically applied whenever you tune into the designed repeater sub-bands in your country.

To activate **ARS**:

1. Short press the **[SET]** key to enter the Menu mode.
2. Rotate the "Main" band **DIAL** to select Menu # 2 (**ARS**).
3. Short press the "Main" band **DIAL** knob, then rotate the "Main" band **DIAL** to change the setting to "ON".
4. Short press the **[SET]** key to save the new setting and exit to normal operation.

If the **ARS** feature has been disabled, or if you need to set a repeater shift direction other than that established by the **ARS**, you may set the direction of the repeater shift manually.

1. Short press the **[SET]** key to enter the Menu mode.
2. Rotate the "Main" band **DIAL** to select Menu # 24 (**RPT.MOD**).
3. Short press the "Main" band **DIAL** knob, then rotate the "Main" band **DIAL** to select the desired shift among "+", "-", and "OFF".
4. Short press the **[SET]** key to save the new setting and exit to normal operation.

And when you travel to a different region, you may need to change the default repeater shift so as to ensure compatibility with local operating requirements.

1. Short press the **[SET]** key to enter the Menu mode.
2. Rotate the "Main" band **DIAL** to select Menu # 27 (**RPT.MOD**).
3. Short press the "Main" band **DIAL** knob, then rotate the "Main" band **DIAL** to select the desired shift among "+", "-", and "OFF".
4. Short press the **[SET]** key to save the new setting and exit to normal operation.

CTCSS Tone / DCS Code Operation

CTCSS setup involves two actions: setting the Tone Mode and Tone Frequency by using the Menu # 31 (**TONE M**) and # 30 (**TONE F**).

1. Short press the **[SET]** key to enter the Menu mode.
2. Rotate the "Main" band **DIAL** to select Menu # 31 (**TONE M**).
3. Short press the "Main" band **DIAL** knob, then rotate the "Main" band **DIAL** and "**ENC**", "**ENC.DEC**" will appear on the display;

ENC: CTCSS Encoder.

ENC.DEC: CTCSS Encoder & Decoder.

Note: you may select the Tone Squelch mode (**ENC**, **ENC.DEC**) on the "Main" band by the microphone's **[P3]** key.

4. When you have made your selection of the CTCSS Tone Mode, short press the "Main" band **DIAL** knob to confirm, then rotate the "Main" band **DIAL** to select Menu # 30 (**TONE F**). This menu is used to set the CTCSS tone frequency.
5. Short press the "Main" band **DIAL** knob to enable adjustment of the CTCSS frequency.
6. Rotate the "Main" band **DIAL** until the display indicates the Tone Frequency you need to be using.
7. When you have made your selection, short press the **[SET]** key to save the new setting and exit to normal operation.

50 groups of Standard CTCSS Tone Frequency (Hz)									
67.0	69.3	71.9	74.4	77.0	79.7	82.5			
85.4	88.5	91.5	94.8	97.4	100.0	103.5			
107.2	110.9	114.8	118.8	123.0	127.3	131.8			
136.5	141.3	146.2	151.4	156.7	159.8	162.2			
165.5	167.9	171.3	173.8	177.3	179.9	183.5			
186.2	189.9	192.8	196.6	199.5	203.5	206.5			
210.7	218.1	225.7	229.1	233.6	241.8	250.3			
254.1	-	-	-	-	-	-			

Just as in CTCSS operation, DCS requires that you set the Tone Mode to DCS and then select a code.

1. Short press the **[SET]** key to enter the Menu mode.
 2. Rotate the "Main" band **DIAL** to select Menu # 31 (**TONE M**).
 3. Short press the "Main" band **DIAL** knob, then rotate the "Main" band **DIAL** and "**DCS**" will appear on the display;
- DCS**: Digital Code Squelch Encoder & Decoder.
- Note**: you may select the Tone Squelch mode (**DCS**) on the "Main" band by the microphone's **[P3]** key.
4. When you have made your selection of the DCS code Mode, short press the "Main" band **DIAL** knob to confirm, then rotate the "Main" band **DIAL** to select Menu # 7 (**DCS.COD**). This menu is used to set the DCS code.
 5. Short press the "Main" band **DIAL** to enable adjustment of the DCS code.
 6. Rotate the "Main" band **DIAL** to select the desired DCS code.

Note: When you have made your selection, short press the **[SET]** key to save the new setting and exit to normal operation. The DCS is an Encoder/Decoder system, so your receiver will remain muted until a matching DCS code is received on an incoming transmission.

104 groups of Standard DCS Code Number															
023	025	026	031	032	036	043	047	051	053	054	065				
071	072	073	074	114	115	116	122	125	131	132	134				
143	145	152	155	156	162	165	172	174	205	212	223				
225	226	243	244	245	246	251	252	255	261	263	265				
266	271	274	306	311	315	325	331	332	343	346	351				
356	364	365	371	411	412	413	423	431	432	445	446				
452	454	455	462	464	465	466	503	506	516	523	526				
532	546	565	606	612	624	627	631	632	654	662	664				
703	712	723	731	732	734	743	754	-	-	-	-				

DCS Code Inversion

If you find that the TH-9800 receiver squelch does not open when both you and the other station are using a common DCS code, you can try the following:

1. Short press the **[SET]** key to enter the Menu mode.
2. Rotate the "Main" band **DIAL** to select Menu # 8 (**DCS.N/R**).
3. Short press the "Main" band **DIAL** knob, then rotate the "Main" band **DIAL** to select the following mode.

TRX N: Both Encoder & Decoder DCS Normal

RX R: Encoder DCS Normal; Decoder DCS Inverted

TX R: Encoder DCS Inverted; Decoder DCS: Normal

TRX R: Both Encoder & Decoder DCS Inverted

4. Short press the **[SET]** key to save the new setting and exit to normal operation.

Tone Search Scanning

In operating situation where you don't know the CTCSS or DCS tone being used by another station or stations, you can command the radio to listen to the incoming signal and scan in search of the tone being used. It works either in the VFO or Memory mode.

To scan for the tone in use:

1. Set the radio up for either CTCSS or DCS decoder operation. In the case of CTCSS, the "**ENC.DEC**" will appear on the display; in the case of DCS, "**DCS**" will appear on the display.
2. Short press the **[SET]** key to enter the Menu mode.
3. Rotate the "Main" band **DIAL** to select Menu # 30 (**TONE F**) when CTCSS is selected, or Menu # 7 (**DCS.COD**) during DCS operation.
4. Short press the "Main" band **Dial** knob to enter adjustment status.
5. Press the "Main" band **[SCN]** key to start scanning for the incoming CTCSS tone or DCS code.

6. When the radio detects the correct tone or code, it will halt on that tone/code, and audio will be allowed to pass. Short press the "Main" band **DIAL** to lock in that tone/code, then press the **[SET]** key to save the new setting and exit to normal operation.

Note: If the Tone scan feature does not detect a tone or code, it will continue to scan. When this happens, it may be that the other station is not sending any tone. Press the **[SCN]** key to halt the scan at any time.

User-defined CTCSS Tone / DCS Code Operation

The TH-9800 has the user-defined CTCSS Tone / DCS Code capability.

For CTCSS Tone:

1. Short press **[SET]** key to enter the Menu mode.
2. Rotate the "Main" band **DIAL** to select Menu # 30 (**TONE F**), short press the "Main" band **DIAL** knob to enter adjustment.
3. Input the Tone frequency by the microphone's key directly. The range is from 60.0 - 260.0 Hz.
4. Press the **[SET]** key to save the new setting and exit to normal operation.

For DCS Code:

1. Short press **[SET]** key to enter the Menu mode.
2. Rotate the "Main" band **DIAL** to select Menu # 7 (**DCS.COD**), short press the "Main" band **DIAL** knob to enter adjustment.
3. Input the DCS code number by the microphone's key directly. The range is from 000 - 777 Normal & Inverted, totally 1024 groups.
4. Press the **[SET]** key to save the new setting and exit to normal operation.

Various Scanning

The TH-9800 allows you to scan just the memory channels, the entire operating band, or a portion of that band. It will halt on signals encountered, so you can talk to the station(s) on that frequency, if you like.

Before you begin to scan, select the way in which you would like the scanner to resume scanning after it halts on a signal. To set the scan-Resume mode:

1. Short press the **[SET]** key to enter Menu mode.
2. Rotate the "Main" band **DIAL** to select Menu # 25 (**SCAN**).
3. Short press the "Main" band **DIAL** knob, then rotate the "Main" band **DIAL** to select the desired scan-resume mode.
TIME: the scanner will halt on a signal it encounters, and will hold 5 seconds. If you do not take action to disable the scanner within 5 seconds, the scanner will resume even if the stations are still alive.
BUSY: The scanner will halt on a signal it encounters. 2 seconds after the carrier has dropped as the other station(s) ceased transmission, the scanner will resume.
4. Press the **[SET]** key to save the new setting and exit to normal operation.

Note: the default setting for scan-resume mode is "TIME".

VFO Scanning

1. Select the VFO mode by pressing **[V/M]** key, if necessary.
2. Press the **[SCN]** key to start scanning.
3. Rotate the "Main" band **DIAL** to change scanning frequency direction.
4. If and when the scanner encounters a signal strong enough to open the squelch, the scanner will halt temporarily; the decimal point of the frequency display will blink during this "Pause" condition.
5. The scanner will then resume according to the Scan-Resume mode selected in previous step.
6. To cancel scanning, press the **[SCN]** key again.

Memory Scanning

1. Select the Memory mode by pressing **[V/M]** key, if necessary.
2. Press the **[SCN]** key to start scanning.

3. As with VFO mode, the scanner will halt on any signal and resume scanning according to the Scan-Resume mode.
4. To cancel the scanning, press the **[SCN]** key again.

Set a "Skipped" Channel During Memory Scan Operation

Some continuous-carrier stations will seriously impede scanner operation and they may be "skipped" during scanning, if you like.

1. Select the Memory mode by pressing the **[V/M]** key, if necessary.
2. Rotate the **DIAL** to select the Memory channel to be skipped.
3. Press and hold the **[SCN]** key for 1/2 second and the "**SKIP**" icon will appear on the display. The current Memory channel will now be ignored during scanning. The "**SKIP**" icon will also appear when you recall the "skipped" memory channel manually.
4. To cancel the "skipped" feature, press and hold the **[SCN]** key for 1/2 second again to select "OFF".

Preferential Memory Scanning

Set up a "Preferential Scan List" of channels which you can "flag" within the memory system. These channels are designated by a "◀" icon when you have selected them.

When you select Preferential Memory Scan mode and start scanning, only those channels bearing the "◀" icon will be scanned.

How to set up and use the Preferential Scan List:

1. Select the Memory mode by pressing the **[V/M]** key, if necessary.
2. Rotate the **DIAL** to select the channel which you wish to add to the Preferential Scan List.
3. Press and hold the **[SCN]** key for 1/2 second, several times if necessary, so as to make the "◀" icon appear by the channel designator.

To scan Preferential Memory Scan:

1. Short press the **[SET]** key to enter the Menu mode.
2. Rotate the "Main" band **DIAL** to select Menu # 26 (**SCAN M**).
3. Short press the "Main" band **DIAL** knob, then rotate the "Main" band **DIAL** to "**MSM**".
4. Press the **[SET]** key to save the new setting and exit to normal operation.
5. Now, press the **[SCN]** key to start Preferential Memory Scanning. Only the channels which have the "◀" icon appended to the channel number will be scanned.
6. To cancel the Preferential Memory Scanning, select "**MEM**" in step 3 above.

Programmable Memory Scan

This feature allows you to set sub-band limits for either scanning or manual VFO operation.

1. Select the VFO mode by pressing **[V/M]** key, if necessary.
2. Store the frequency 1 into Memory Channel # L1 (the "L" designates the Lower sub-band limit).
3. Likewise, store the frequency 2 into Memory Channel # U1 (the "U" designates the upper sub-band limit).
4. Switch to the Memory mode by pressing **[V/M]** key once, then rotate the **DIAL** to select Memory Channel # L1.
5. Press and hold in the **[V/M]** key for 1/2 second to start operation; the "**MT**" label will appear on the display. Tuning and scanning will now be limited within the just-programmed range.
6. Five pairs of Band Limit memories, labeled L1/U1 through L5/U5 are available. You therefore can set upper and lower operation limits on a number of bands, if you like.

Note:

Please make sure CH # L1 frequency is lower than CH # U1 frequency and both of them are in the same frequency band. If not it will be invalid.

Priority Channel Scanning (Dual Watch)

The TH-9800 has a two-channel scanning capability which allows you to operate on a VFO, Memory channel, or Home

channel, while periodically checking a user-defined "Priority" Memory Channel for activity.

VFO Priority

1. Recall the memory channel you wish to use as the "priority" frequency.
2. Select the VFO mode by **[V/M]** key, if necessary.
3. Press and hold in the **[HM]** key for 1/2 second to activate the VFO priority mode. The display will remain on the VFO frequency, but every 5 seconds the TH-9800 will check the Priority Channel for activity.
4. Press the **[V/M]** key to disable the VFO Priority mode and exit to regular VFO operation.

Memory Priority

1. Store the frequency you wish to be the "Priority" Channel into memory channel "1".
2. Set the TH-9800 for operation on another memory channel.
3. Press and hold in the **[HM]** key for 1/2 second to activate the Memory Priority mode. The display will remain on the current memory channel frequency, but every five seconds the TH-9800 will check the Priority Channel (memory channel "1") for activity.
4. Press the **[V/M]** key to disable the Memory Priority mode and exit to regular memory operation.

DTMF Signaling Operation

The TH-9800 has two methods to start DTMF signaling.

1 - Using the microphone's numeric keys

Press and hold PTT switch then directly input the other station(s) telephone numbers by using the microphone's numeric keys, 0 ~ 9, *, #, A, B, C, D.

2 - Using the DTMF Autodialer feature

16 DTMF autodialer memories are available. These DTMF autodialer memories can store up to 16 digits of a telephone number for: repeater autopatch or other uses.

To load DTMF autodialer memories:

1. Short press the **[SET]** key to enter the Menu mode.
2. Rotate the "Main" band **DIAL** to select the Menu # 12 (**DTMF W**).
3. Press the "Main" band **DIAL** knob, then rotate the "Main" band **DIAL** to select the DTMF Autodialer memory channel number ("d-1" - "d-16") into which you wish to store a telephone number.
4. Press the "Main" band **DIAL** knob then rotate the **DIAL** to select the first digit of the telephone number you wish to store.
5. When you have selected the correct digit, press the **DIAL** knob to confirm. Now rotate the "Main" band **DIAL** to select the second of the 16 available numbers in this current DTMF autodialer memory register.
6. Repeat this procedure for each digit in the telephone number. If you make a mistake, press the microphone's **[DWN]** key to move back to the first digit, then re-enter the correct number. Press the **[SCN]** key to clear previous digits.
7. When entry of all digits is complete, press the **[SET]** key to save the new setting.
8. If you wish to store another DTMF string, rotate the "Main" band **DIAL** to select another DTMF memory register, then repeat steps 4 through 7 above.
9. When all required DTMF memories are filled to your need, press the **[SET]** key to save and exit to normal operation.

To transmit the memorized telephone number:

1. Press the **[SET]** key to enter the Menu mode, rotate the **DIAL** to select the DTMF autodialer memory channel to be transmitted through Menu # 15 (**DTMF W**).
2. Press the **[SET]** key to save and exit to the normal operation.
3. Press and hold **PTT** switch, press the "Main" band **[HM]** key to transmit the tone string.

Once you have pressed the **[HM]** key in the above step, you can release the **PTT**, as the autodialer will transmit the whole DTMF string automatically.

And you can set DTMF digits sending speed levels and the delay time between you press the **[HM]** key (with **PTT** pressed) and the first DTMF digit is sent through Menu # 11 (**DTMF S**) and Menu # 10 (**DTMF D**).

2 Tone & 5 Tone Signaling Operation

The difference between 2/5 Tone and DTMF operation is that 2/5 Tone can be sent using the autodialer feature only, not by the microphone's numeric keys. And you can load 2/5 Tone autodialer memories by the PC programming software only, not by manual.

To transmit the memorized 2/5 Tone signaling:

1. Select 2 Tone memorized channel through Menu # 38 (**2 TONE**), Menu # 39 (**5 TONE**).
2. Press and hold **PTT** switch, press the "Main" band **[LOW]** key to transmit 2 Tone signaling; press the "Main" band **[VIM]** key to transmit 5 Tone signaling.

Auto Range Transponder System (ARTS) Operation

The ARTS feature uses DCS code to inform both parties when you and another ARTS-equipped station are within communications range. This may be particularly useful during Search and Rescue situations, where it is important to stay in contact with other members of your group.

Both stations must set up their DCS codes to the same code number, then activate their ARTS feature using the command appropriate for their radio.

Whenever you push the **PTT** switch, or every 25 seconds after ARTS is activated, your radio will transmit a signal which includes a DCS code for about one second. If the other radio is in range, the beeper will sound (if enabled) and the display will show **"IN.RNG"** as opposed to the out of range display **"OUT.RNG"** in which ARTS operation begins.

If you move out of range for more than one minute, your radio will sense that no signal has been received, three beeps will sound, and the display will revert to **"OUT.RNG"**. If you move back into range, your radio will again beep, and the display will change back to the **"IN.RNG"** indication.

During ARTS operation, it is not possible to change the operating frequency or other settings on the "Main" band; you must stop ARTS in order to resume normal operation.

To activate ARTS:

1. Set your radio and other radios to the same DCS code number.
 2. Press the [SET] key to enter the Menu mode.
 3. Rotate the "Main" band **DIAL** to select Menu # 3 (**ARTS**).
 4. Press the "Main" band **DIAL** knob and rotate the **DIAL** to select the desired ARTS beep option.
- IN.RNG:** The beeps are issued only when the radio first confirms that you are within range, but does not re-confirm with beeps thereafter.
- ALWAYS:** Every time a polling transmission is received from the other station, the alert beeps will be heard.
5. Press the "Main" band **DIAL** knob to confirm and the "**OUT.RNG**" will display on the LCD. ARTS operation has now commenced.
 6. Every 25 seconds, your radio will transmit a "polling" call to the other station. When the station doesn't respond with its own ARTS polling signal, the display will change to "**OUT.RNG**" to confirm that other station's polling code was not received in response to yours.
 7. Press the [SET] key to exit **ARTS** operation and exit to normal operation.

Cross-band Repeater Operation

The TH-9800 can be set up to operate as a cross-band repeater via a simple Menu procedure. This feature is useful for emergency portable work in a remote area, and for cross-band linking.

Note:

1. Check the relative rules and regulations for your country to ensure that this type of operation is permitted.
2. Pick your frequency pair carefully, so as not to cause harmful interference to other users. If you are not sure of activate repeater frequencies in your area, a safe rule is to stay off of the repeater sub-bands and use the FM simplex portion of each band. Contact your area's frequency coordinator for guidance.

3. Remember that the transmit duty cycle will be much higher during repeater service, so we recommend that the transmit power level be set to a Low level, to ensure cooler operation.

How to set up cross-band repeater operation:

1. Configure both bands setting as desired and the squelch such that background noise is silenced before enabling cross-band repeater operation.
2. Press the [SET] key to enter the Menu mode.
3. Rotate the "Main" band **DIAL** to select Menu # 35 (**X-PRT**).
4. Press the "Main" band **DIAL** knob once, "**XSTART**" will appear on the display.
5. Press the "Main" band **DIAL** knob again to activate the cross-band repeater mode. Now the "**TX**" icon will disappear on the display. And both the left and right bands can be used for transmitting or receiving.
6. Press the [SET] key to exit the cross-band repeater mode.

Microphone Key Assignments

TH-9800 microphone's [P1]/[P2]/[P3]/[P4] buttons can be assigned different function by the user, if you wish to utilize another function on one of these keys.

To assign the function to a key:

1. Press the [SET] key to enter the Menu mode.
2. Rotate the "Main" band **DIAL** to select the Menu # 19 - # 22 to be configured (# 19 **PG P1**, # 20 **PG P2**, # 21 **PG P3**, # 22 **PG P4**)
3. Press the "Main" band **DIAL** knob, then rotate the "Main" band **DIAL** to select the function you wish to assign to the button you selected in the previous step.
4. Press the [SET] key to save the new setting and select another programmable button to modify, and repeat the above steps.
5. Press the [SET] key to save the setting and exit to the normal operation.

Name	Function
SCAN	Activate the Scanner on the "Main" band.
SQL-OFF	Opens the Squelch on the "Main" band to allow un-muted reception.
TCALL	Activates 1750 Hz Tone Burst (1000/1450/1750/2100 Hz tone can be selected in the programming software).
RPTR	Selects Repeater Shift direction on the "Main" band.
PRI	Activates the Priority feature on the "Main" band.
LOW	Selects the transmit power output level on the "Main" band.
ZONE	Activates the CTCSS or DCS operation on the "Main" band.
MHZ	Allows tuning in 1 MHz step on the "Main" band.
REV	Reverses the TX and RX frequencies during split-frequency operation.
HOME	Switches operation to the "Home" channel on the "Main" band.
BAND	Switch the "Main" band of operation between the "left" band and "right" band.
VFO/MR	Switches frequency control between the VFO and Memory modes on the "Main" band.

Menu Operation

Procedure:

1. Short press the [SET] key to enter the Menu mode.
2. Turn the "Main" band **DIAL** to select the Menu item to be adjusted (You can recall the Menu items using the microphone directly).
3. Short press the "Main" band **DIAL** knob to enable adjustment, then rotate the **DIAL** to perform the actual adjustment.
4. After completing your adjustment, short press the [SET] key to save the new setting to exit to normal operation.

1 Automatic Power OFF - APO

Function: selects the APO time (time before power goes off),

Available Values: OFF / 0.5H / 1H / 2H

Default: OFF

2 Automatic Repeater Shift - ARS

Function: enable/Disable the ARS feature.

Available Values: ON / OFF

Default: OFF

3 Auto Range Transponder System - ARTS

Function: select the ARTS beep mode.

Available Values: IN RNG / ALWAYS

IN RNG: Activates the ARTS feature; a high tone will sound when the transceiver first detects that you are within range, and a low beep will sound when the other station goes out of range.

ALWAYS: Activates the ARTS feature; a high tone will sound every time a polling transmission is received from the other station, and a low beep will sound once when the other station goes out of range.

4 BEEP

Function: enable/Disable the beeper
Available Values: BEP.ON / BEP.OFF
Default: BEP.ON

5 Clock frequency shift - CLK.SFT

Function: shifting of CPU clock frequency
Available Values: SFT.ON / SFT.OFF
Default: SFT.OFF

6 DIMMER

Function: setting of the display brightness level.
Available Values: DIM. OFF / 1 / 2 / 3 / 4
Default: DIM 3

7 DCS.COD

Function: setting the DCS code.
Available Values: 104 standard DCS codes,
Default: 023

8 DCS.N/R

Function: select "Normal" or "Inverted" DCS coding.
Available Values: TRX N / TX R / RX R / TRX R
Default: TRX N

9 DSP.MOD

Function: select Memory channel display mode.
Available Values: DSP.FRQ / DSP.NAM
Default: DSP.FRQ

10 DTMF D

Function: setting of the DTMF autodialer delay time.
Available Values: 50 / 250 / 450 / 750 / 1000 MS.
Default: 450 MS.

11 DTMF S

Function: setting of the DTMF autodialer sending speed.
Available Values: 50 / 75 / 100 MS.
Default: 50 MS.

12 DTMF W

Function: loading of the DTMF autodialer memories.
16 DTMF autodialer memories are available.

13 HYPER

Function: enable/disable the automatic writing feature for the Hyper Memory.
Available Values: MANUAL / AUTO
Default: MANUAL

14 KEY.MOD

Function: select the key functions for the "right" band function switches.

Available Values: KEY1 / KEY2

Default: KEY1

15 LOCK

Function: enable/disable the Key/Button Lock feature.

Available Values: MANUAL / AUTO

Default: MANUAL

16 LOCKT

Function: enable/disable the PTT lock feature.

Available Values: OFF / BAND R / BAND L / BOTH

Default: OFF

OFF: Enable the PTT switch.

BAND R: Disable the PTT switch on the "right" band.

BAND L: Disable the PTT switch on the "left" band.

BOTH: Disable the PTT switch on the "both" band.

17 MUTE

Function: select the audio mute mode.

Available Values: OFF / TX / RX and TX/RX

18 NAME

Function: store an alpha tag for a memory channel.

19 PG P1

Function: program the microphone's [P1] button assignment.

Default: BAND

20 PG P2

Function: program the microphone's [p2] button assignment.

Default: VFO/MR

21 PG P3

Function: program the microphone's [p3] button assignment.

Default: TONE

22 PG P4

Function: program the microphone's [p4] button assignment.

Default: LOW

23 RF SQL

Function: Adjust the RF SQL threshold level.

Available Values: OFF / S-2 / S-5 / S-9 / S-FULL

Default: OFF

Note: The Menu Item can be set independently on both the "left" and "right" bands.

24 RPT.MOD

Function: set the repeater shift direction.

Available Values: RPT.OFF / RPT.- / RPT.+

Default: RPT.OFF

Note: The repeater shift can be set independently on both the "left" and "right" bands.

25 SCAN

Function: selects the scan-resume mode.

Available Values: TIME / BUSY

Default: TIME

TIME: the scanner will halt on a signal it encounters, and will hold 5 seconds. If you do not take action to disable the scanner within 5 seconds, the scanner will resume even if the stations are still alive.

BUSY: The scanner will halt on a signal it encounters, 2 seconds after the carrier has dropped as the other station(s) ceased transmission, the scanner will resume.

26 SCAN MODE

Function: selects the memory scan mode.

Available Values: MEM / MSM

Default: MEM

MEM: Enables Memory Scanning on all the memory channels (except the memory channel skip memory).

MSM: Enables Memory Scanning on Preferential Memory Channels only.

27 SHIFT

Function: set the offset of the repeater shift.

Available Values: 0.00 – 99.5 MHz

Default: 600 KHz (UHF), 600 Hz (VHF)

Note: the shift can be set independently for each band.

28 STEP

Function: set the synthesizer steps.

Available Values: 2.5 / 5 / 6.25 / 7.5 / 8.33 / 10 / 12.5 / 15 / 25 / 30 / 50 / 100 KHz

Default: 12.5 KHz

Note: the step can be set independently for each band.

29 SPK

Function: set the squelch mode.

Available Values: SQ / CTC / TON / C+T and C/T

Default: SQ

SQ: open the squelch when receive a matching carrier.

CTC: open the squelch when receive a matching carrier and exact CTCSS tone / DCS code.

TON: open the squelch when receive a matching carrier and exact DTMF/2TONE/5TONE signaling.

C+T: open the squelch when receive a matching carrier, exact CTCSS tone/DCS code and DTMF/2TONE/5TONE signaling.

C/T: open the squelch when receive a matching carrier and either CTCSS tone/DCS code or DTMF/2TONE/5TONE signaling.

30 TONE F

Function: set the CTCSS tone frequency.

Available Values: 50 standard CTCSS tones.

Default: 100 Hz.

Note: the CTCSS tone can be set independently for each band and each memory channel.

31 TONE M

Function: select the tone encoder and/or decoder mode.

Available Values: OFF / ENC / ENC.DEC / DCS.

Default: OFF.

ENC: CTCSS Encoder.

ENC.DEC: CTCSS Encoder/Decoder.

DCS: Digital Code Squelch Encoder/Decoder.

32 Time-Out Timer - TOT

Function: set the time-out timer.

Available Values: OFF / 1 ~ 30 min

Default: 6 min

33 Talk Around - TALKAR

Function: change to simplex working mode when you are out of the repeater range or the repeater is not activated.

Available Values: ON / OFF

Default: OFF

34 WID.MID.NAR

Function: select bandwidth to reduce the MIC gain (and Deviation).

Available values: WIDE/MID/NARROW

Default: WIDE

Note: the bandwidth can be set independently for each band.

35 Cross-band repeater - X-RPT

Function: enable/disable the Cross-band repeater feature.

36 AM

Function: enable/disable the AM mode.

Available Values: ON / OFF

Default: OFF

37 AUT-AM

Function: enable/disable automatic AM mode.

Available Values: ON / OFF

Default: ON

38 2TONE

Function: assign the 2 Tone autodialer memory channel.

Available Values: 2T-01 ~ 2T-16

Default: 2T-01

39 5TONE

Function: assign the 5 Tone autodialer memory channel.

Available Values: 5T-01 ~ 5T-16

Default: 5T-01

40 SCR - Scramble

Function: enable/disable the scramble feature.

Available Values: ON / OFF

Default: OFF

41 COMP - Compander

Function: enable/disable the voice compander feature.

Available Values: ON / OFF

Default: OFF

42 HSD.TYP

Function: activate 2 TONE/ 5 TONE/ DTMF Squelch.

Available Values: OFF / 2 TONE / 5 TONE / DTMF

Default: OFF

Factory Reset Operation

Procedure:

1. Turn the radio off.
 2. Press and hold the **LEFT [LOW]** key while turning the radio on.
 3. Rotate the **DIAL** to select the resetting menu.
- F-1 SETMOD RESET:** Reset the menu settings to their factory defaults.
- F-2 HYPER RESET:** Clears the Hyper Memory settings to factory defaults.
- F-3 MEMORY RESET:** Clears the regular Memory settings to factory defaults.
- F-4 ALL RESET:** Clears all the memories and other setting to factory defaults.
4. Once you have made your selection in step 3, short press the **[SET]** key to complete the reset procedure.

Simple Trouble Shooting

Problem	Possible Causes and Potential Solutions
Power is on, but nothing appears on the display.	"+" and "-" polarities of power connection are reversed. Connect Red lead to positive terminal and black lead to negative terminal of DC power supply.
Fuse is blown.	Check and solve problem resulting in blown fuse and replace with new one.
Display is too dark.	Adjust display brightness level to high.
No sound comes from speaker.	Squelch is muted. Reduce squelch level. CTCSS/DCS and DTMF/2 TONE/5 TONE Squelch is active. Turn them off.
Key and Dial doesn't work.	Keypad lock is activated. Disable it.
Press PTT key but TX doesn't work.	Microphone or antenna connection is poor. Connect them properly.

Specifications

General

Frequency Range (Default)	Left Band RX: 26.000-33.000MHz, 47.000-54.000MHz, 108.000-180.000MHz, 320.000-512.000MHz, 750.000-950.000MHz (except cell phone). TX: 26.000 - 33.000 MHz, 47.000 - 54.000 MHz, 134.000 - 174.000 MHz, 400.000 - 480.000 MHz
Note: 66 - 88 MHz & 220 - 260 MHz are optional bands and could be available for some special requirement.	Right Band RX: 134.000 - 180.000 MHz, 400.000 - 512.000 MHz TX: 134.000 - 174.000 MHz, 400.000 - 480.000 MHz 2.5/5/6.25/7.5/8.33/10/12.5/15/25/30/50/100 KHz
Channel Steps	FM
Modes of Emission	50 Ohms, unbalanced (Antenna Duplexer built-in)
Antenna Impedance	± 5ppm
Frequency Stability	-20°C ~ +60°C
Operating Temperature Range	13.8 V DC (± 5%)
Supply Voltage	RX: 0.5 A (Squelched) TX: 8.5 A
Current Consumption	140 x 41.5 x 168 mm
Case Size (W x H x D)	1.2 Kg
Weight	

Transmitter

Output Power	50 / 20 / 10 / 5 W (29/50/144 MHz) 40 / 20 / 10 / 5 W (430 MHz) ± 5KHz
Maximum Deviation	< -60dB (29 MHz: < -50dB)
Spurious Radiation	< 3%
Modulation Distortion	2 kΩ
Microphone Impedance	

Receiver

Intermediate Frequencies	49.95 MHz / 450 KHz (Left band) 38.85 MHz / 450 KHz (Right band)
Sensitivity (for 12dB SINAD)	<0.2 μ V
Squelch Sensitivity	<0.16 μ V
Selectivity	12 KHz/30 KHz
Maximum AF Output	2 W @ 8Ω for 5% THD