

**BAOFENG**

Two Way Radio  
**GT-5R**

# User Manual

V1.0

**BAOFENG**

FIND TUTORIALS, SUPPORT AND MORE

[www.baofengradio.com](http://www.baofengradio.com)



<https://www.facebook.com/BaofengOfficial>



Scan  
for details!

FC CE 06780  RoHS

**Safety Information**

The following safety precautions should always be observed during operation, service and repair of this equipment.

- This equipment shall be serviced by qualified technicians only.
- Do not modify or taper with the radio for any reason.
- Do not use any portable radio with a damaged antenna. If a damaged antenna comes into contact with your skin, a minor burn can result.
- Turn off your radio prior to entering any area with explosive and/or flammable materials.
- Do not charge your battery in an area with explosive or flammable materials.
- Turn off the radio before boarding an aircraft. Any use of the radio must be in accordance with airline regulations or crew instructions.
- Do not place the radio over an air bag area or in the air bag deployment area for vehicles equipped with an air bag.
- Do not expose the radio to direct sunlight over a long period of time, nor place it close to any heat source.

**FCC Warning**

Operation is subject to the following two conditions:

- This device may not cause interference.
- This device must accept any interference, including interference that may cause undesired operation of the device.

**RF Exposure Compliance Statement and Operating Instructions**

The device has been tested against the SAR limit (1.6W/kg). The highest SAR value reported under this standard during product certification for use at the Face up is 0.885W/kg and when properly worn on the body is 0.997W/kg. This device was tested for typical operations.

The device only supports simplex-mode and transmitting is no more than the rated duty cycle factor of 50% of the time. For hand-held operation, the radio should be held at least 25mm from the user's face. The use of belt clips, holsters and similar accessories should not contain metallic components in its assembly. The use of accessories that do not satisfy these requirements may not comply with RF exposure requirements, and should be avoided. Use only the supplied or an approved antenna.

**Table of Contents**

**Part I: Getting Start** .....01

Chapter 1. - What's in the Box.....01

Chapter 2. - Charging and Battery Maintenance .....01

Chapter 3. - Introduction to Buttons.....03

**Part II: Basic Functions**.....07

Chapter 4. - Basic Use.....07

Using Settings Menu Short-cuts.....10

Chapter 5. - Scanning.....11

Scanning a Frequency Range (VFO Mode).....12

Chapter 6. - Dual Watch.....13

Chapter 7. - DTMF41.....14

Chapter 8. - Selective Calling.....15

CTCSS.....15

DCS.....16

1000Hz, 1450Hz, 1750Hz Tone-burst.....17

Chapter 9. - Customization.....17

**Part III: Programming**.....19

Chapter 10. - Preparation before Programming.....19

Chapter 11. - Chirp Software Programming Process.....20

**Part IV: Advanced Features**.....22

Chapter 12. - Channel Setting.....22

Chapter 13. - Repeaters.....23

Chapter 14. - Application Specific Setup.....25

**Part V: Appendix**.....27

Appendix A. - Troubleshooting.....27

Appendix B. - Menu definitions.....28

Appendix C. - Technical specifications.....36

## Part I: Getting Start

### Chapter 1. - What's in the Box

- 1 x BAOFENG GT-5R Radio
- 1 x 1800mAh Li-Ion Battery
- 1 x Antenna
- 1 x Desktop Charger
- 1 x Adapter
- 1 x Original Earpiece
- 1 x Wrist Strap
- 1 x Belt Clip
- 1 x User Manual

### Chapter 2. - Charging and Battery Maintenance

#### Charging the Battery

 The battery should be fully charged before initial use. Optimum battery efficiency will be achieved after three full battery charge and discharge cycles.

The charger and battery are fitted with matching notches so that the battery can be charged when removed from the radio. This allows you to charge a separate battery while using the radio.

The radio should be POWERED OFF during the charge cycle if the radio is inserted into the charger.

#### Charger LED Codes

LED Codes	States
Flashing	Standby (charger empty), the charger works normally.
Red LED	Charging
Green LED	Charging is complete.

#### Battery Maintenance

At the beginning the battery is provided fully charged from the factory, but it would be naturally consumed during transportation. Please fully charge the battery before using your radio the first time.

- Use only batteries approved by Baofeng.
- Never attempt to disassemble the battery pack.
- Do not expose the battery to fire or intense heat.
- Dispose of batteries in accordance with local recycling regulations.

#### Prolonging Your Battery's Life

- Before charging is completed, do not unplug the power to the charger or remove the battery.
- Only charge the battery in normal room temperatures.
- Battery's performance will be reduced in low or freezing temperatures. When working in cold environments, it is suggested to carry a spare battery, inside your jacket or in a similar location in order to keep the battery warm.
- Dust can interfere with the connection between the battery and the radio. If necessary wipe the contacts with a clean dry cloth to ensure proper contact between the radio and battery.
- Never charge or use a battery which is wet or damaged.

If your battery has become wet, remove it from the radio, wipe it dry with a towel or soft tissue, and put it in a sealed plastic bag with a handful of dry rice for at least 24 hours allowing the dry rice to absorb any moisture.

This method may only be effective against minor splashes (light rain for instance). A radio whose internal components exposed to moisture may be permanently ruined.

#### Battery Storage

In order to prevent damage from over-discharge, the battery must be stored with a partial charge. (80% charge is a good guideline). This radio uses a lithium-based battery and an 80% charge is recommended.

This level minimizes age-related capacity loss while keeping the battery in operating conditions and allowing for some self-discharge. Always remove the battery from the radio when storing.

**Chapter 3. - Introduction to Buttons**

BAOFENG Radio, overview

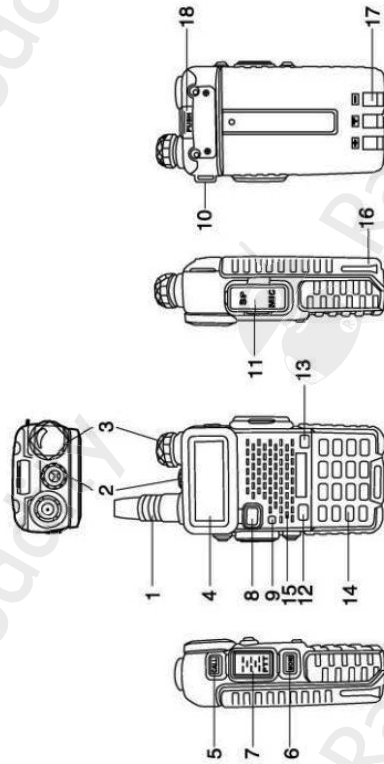

1. Antenna	10. Strap Buckle
2. Flashlight	11. Accessory Jack
3. Knob (ON/OFF, volume)	12. A/B key (frequency display switches)
4. LCD	13. BAND Key (band switches)
5. SK - Side Key1/CALL (radio, alarm)	14. Keypad
6. SK - Side Key2/MONI (flashlight, monitor)	15. SP. & MIC.
7. PTT Key (push-to-talk)	16. Battery Pack
8. VFO/MR (frequency mode/channel mode)	17. Battery Contacts
9. LED Indicator	18. Battery Remove Button

**Please make sure to install the antenna and the battery is fully charged when you start using the radio.**

**The Main Display**

BAOFENG Radio, display

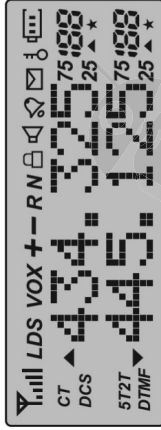

**LCD icon summary**

Icon	Description	Icon	Description
Memory channel	R	Reverse function enabled	
Frequency Least significant modifiers.	N	Narrowband enabled	
CTCSS enabled	CTCSS	Battery level indicator	
DCS enabled	Ⓛ	Keypad lock enabled	
Frequency shift direction (Offset)	L	Low Power Enabled	
Channel Scan Enabled	▲▼	High Power enabled When X7 not Displayed.	
Dual watch enabled	▲▼	Indicates active band or channel.	
VOX enabled	VOX	Squelch Open/Close Indicator	

**Battery Level Indicator**

When the battery level indicator reads the battery is depleted. At this point, the radio will start beeping periodically as well as flashing the backlight of the display and when voice prompts are enabled, a "Low Voltage" announcement will be heard, indicating that you need to change your battery or put your radio in the charger.

**Side key 1 - CALL (Broadcast FM and Alarm Selection Button)**

Press the CALL button momentarily to start the broadcast FM receiver. Another momentary press turns the broadcast FM receiver off. If a signal is received on the active frequency or channel while you are listening to the broadcast FM, the squelch will be activated to that frequency (as if scanning) and the squelch will remain activated until the signal goes away; it will then switch back to broadcast FM.

Press and hold the MONI button to activate the alarm function. Press MONI (a short press) again to turn it off.

**Side key 2 - MONI (Monitor and Flashlight)**

Press **[MONI]** momentarily to turn on the LED flashlight. Another momentary press will cause the flashlight LED to flash. Another momentary press turns the flashlight off.

Press **[MONI]** and hold to monitor the signal of the selected channel A or B. This will turn off the squelch so you can listen to the unfiltered signal.

**VFO / MR - Mode Key**

Pressing **[VFO/MR]** switches between Variable-frequency oscillator (VFO) Mode and Memory (MR) mode. Memory mode is sometimes also referred to as Channel mode. Variable-frequency oscillator (VFO) mode allows the frequency to be entered manually by pressing the digits of the numeric keypad.

To save frequencies to channel memory you must first be in Variable-frequency oscillator (VFO) mode.

**A / B Select Key**

The **[A/B]** key switches between the A (upper) and B (lower) seven character displays. The frequency or channel on the selected display becomes the active listening and transmit frequency or channel.

To save frequencies to channel memory you must first be on the A display.

**Numeric Keypad**

The BAOFENG Radio comes standard with a full numeric keypad.

**BAOFENG Radio, keypad**

The numeric keys have their secondary function printed on them (in reality, it's the settings menu shortcuts, more on that in Chapter 4, Working the Menu System).

The SCAN and **[#]** keys, on the other hand, have actual secondary functions, scan and keypad lock respectively. In channel mode, **[#]** also acts as a transmit power shift key. While in channel mode, momentarily pressing **[#]** to change between High and Low transmit power. Do note that this does not alter the transmit power stored to memory for that channel; it only affects the current transmit power. (Switching to another channel or another operating mode including broadcast FM) will reset transmit power to what's stored in the channel's memory.)

**Keypad Lock**

The BAOFENG Radio features a keypad lock that locks out all keys except for the three side keys.

To enable or disable the keypad lock, press and hold the **[#]** key for about two seconds.

You can also enable the keylock so that the radio automatically locks the keypad after ten seconds from the Settings menu, see Chapter 4, Working the Menu System.

**Star \* Key**

A short momentary press of the key enables the reverse (R) function (see Chapter 11 Repeaters). When listening to broadcast FM a momentary press will start scanning the Broadcast FM Radio station frequencies. Scanning in Broadcast FM will stop as soon as an active station is found, regardless of the scanner resume method in the device settings menu.

To enable the scanner, press and hold the **[\*SCAN]** key for about two seconds. See Chapter 5, Scanning for details.

### Accessory Jack

The accessory jack on the BAOFENG Radio is a Kenwood compatible two (2)-pin design.



To attach accessories such as headsets, speaker-microphones or programming cables, align the connectors and fully push in.

## Part II: Basic Functions

### Chapter 4. - Basic Use

#### Power and Volume

Before turn the power on, make sure you have attached the battery and antenna as described in Chapter 1, Initial Setup.

#### Turning the Unit On

To power the radio on, simply rotate the volume/power knob clockwise until you hear a "click". If your radio powers on correctly there should be an audible double beep after about one second and the display will show a message or flash the LCD depending on settings for about one second (see "38 PON MSG - Power On Message" in Appendix B' Menu definitions). Then it will display a frequency or channel. If the Voice prompt is enabled, the voice will announce "frequency mode" or "channel mode".

First power-on, display

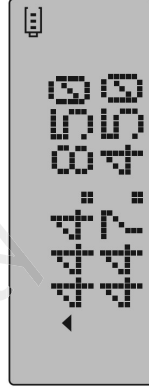

You can get additional information about your radio when you turn it on by holding down miscellaneous keys as you turn it on.

#### Turning the Unit Off

Turn the volume/power knob counter-clock wise all the way until you hear a "click". The radio will be off.

#### Adjusting the Volume

To turn up the volume, turn the volume/power knob clock-wise. Be careful not to turn it too far, as you may inadvertently turn your radio off.



By using the monitor function, enabled from **[MON]** key below the PTT, you can more easily adjust your volume by adjusting it to loudness of the un-squelched static.

#### Making a Call

Press PPT——sending signal

Release TT——receiving signal

When transmitting, keep the radio's microphone 3-4 centimeters away from your mouth, and keep the antenna up and at least 5 centimeters away from the body.

#### Variable Frequency Oscillator (VFO) Mode

In Variable Frequency Oscillator (VFO) mode you can navigate up and down the band by using the **[V]** and **[D]** keys. Each press will increment or decrement your frequency according to the frequency step you've set your transceiver to in the radio settings. For details on how to set the frequency step on your transceiver see Chapter 4, Working the menu system and the section called "1 STEP - F frequency Step" in Appendix B, Menu definitions. You can also input frequencies directly on your numeric keypad with kilohertz accuracy. However, the radio will floor (round) to the nearest frequency that corresponds to your frequency step. In other words, when you input frequencies with greater than 1kHz resolution (such as 445.6875 MHz in the example below), always round your input up. The following example assumes the use of a 12.5kHz frequency step

### Entering the frequency 445.6875 MHz on display A

1. Use the **[VFO/MR]** key to switch to Variable Frequency Oscillator (VFO) mode.
2. Press **[A/B]** until the **[>]** appears next to the upper display (display A).
3. Enter **[4] [0] [X] [4] [0] [X] [5] [WR]** on the numeric keypad, it should look something like this:

#### Partially entered frequency input

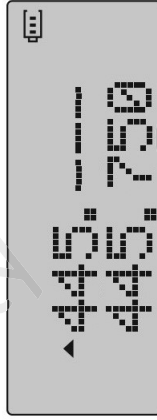

4. Now, for the final four digits. Note that you can only enter three decimals on the keypad, if you type 687, it won't work. So how do you get the fourth and final digit 5 in there? By rounding 445.6875 up to 445.6880 MHz, an alternative is entering 445.675, and then pressing the **[>]** key once to move it up to 445.6875.

Enter **[6] [MR] [8] [BEEP] [8] [BEEP]** on the numeric keypad, if all went well the display should look something like this:

#### Successful frequency input

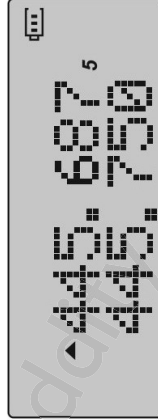

Just because you can program in a channel does not mean you're automatically authorized to use that frequency. Transmitting on frequencies you're not authorized to operate on is illegal, and in most jurisdictions a serious offense. If you get caught transmitting without a license you can and will get fined, and in a worst case scenario sent to jail. However, it is legal in most jurisdictions to listen. Contact your local regulatory body for further information on which laws, rules and regulations apply to your area.

### Memory/Channel (MR) Mode

The use of Memory/Channel (MR) mode is dependent on actually having programmed in some memory channels to use. To find out more on how to program channels see Chapter 10, Programming.

Once you have channels programmed and ready, you can use the **[<]** and **[>]** keys to navigate between channels.



If you have channels programmed with Transmit power set to Law, you can use **[MR]** key to temporarily switch over to high power if you're having trouble getting through.

### Quick Start Guide

For a complete reference on available menu items and parameters, see Appendix B, Menu definitions.



If your radio is set to Memory/Channel (MR) mode. The following menu items will not take any effect: STEP, TXP, W/N, CTCSS, DCS, S-CODE, PTT-ID, BCL, SFT-D, OFFSET, MEM-CH, BAND

1. Press the **[MENU]** key to enter the menu.
2. Use the **[<]** and **[>]** keys to navigate between menu items.
3. Once you find the desired menu item, press **[MENU]** again to select that menu item.
4. Use the **[<]** and **[>]** keys to select the desired parameter value.
5. When you've selected the parameter you want to set for a given menu item:
  - a. To confirm your selection, press **[MENU]** and it will save your setting and bring you back to the menu setting you just edited.
  - b. To cancel your changes, press the EXIT button on the keypad and it will reset that menu item and bring you out of the settings menu completely.
6. To exit out of the menu at any time, press EXIT the key.

### Using Settings Menu Short-cuts

As you may have noticed if you looked at Appendix B, Menu definitions, every menu item has a numerical value associated with it. These numbers can be used for direct access of any given Settings menu item.

The parameters values also have a number associated with them, see Appendix B, Menu definitions for details.

**Using the menu with short-cuts**

1. Press the **[MENU]** key to enter the menu.
2. Use the numeric keypad to enter the number of the menu item.
3. To edit that menu item, press the **[MENU]** key.
4. To enter the desired parameter value, you have two options:
  - a. Use the arrow keys as we did in the previous section. Or:
  - b. Use the numeric keypad to enter the numerical short-cut value.
5. And just as in the previous section:
  - a. To confirm your selection, press **[MENU]** and it will save your setting and bring you back to the menu setting you just edited.
  - b. To cancel your changes, press **[EXIT]** and it will reset that menu item and bring you out of the Settings menu completely.
6. To exit out of the Settings menu at any time, press the **[EXIT]** key.
7. All further examples and procedures in this manual will use the numerical menu shortcuts.

**Chapter 5. - Scanning**

The BAOFENG Radio features a built in scanner for the VHF and UHF bands. When in Variable Frequency Oscillator (VFO) mode it will scan in steps according to your set frequency step. In Memory/Channel (MR) mode it will scan through your saved channels.

Dual Watch is inhibited while scanning.

To enable the scanner, press and hold the **[\*SCAN]** key for about two seconds. Press any key to exit scanning mode.

**Scanning Modes**

The scanner is configurable to one of three ways of operation: Time Operation(TO), Carrier Operation (CO) or Search Operation (SE) , each of which is explained in further details in their respective section below.

**Setting Scanner Mode**

1. Press the **[MENU]** key to enter the menu.
2. Enter **[1 STEP 8 STEP]** on your numeric keypad to navigate to the Settings Menu item number 18 (SC-REY) to edit the scanner mode .
3. Press the **[MENU]** key to select.
4. Use the **[<]** and **[>]** keys to select scanning mode.
5. Press the **[MENU]** key to confirm and save.
6. Press the **[EXIT]** key to exit the menu.

**Time Operation**

In Time Operation (TO) mode, the scanner stops when it detects a signal, and after a factory pre-set time out, it resumes scanning.

**Carrier Operation**

In Carrier Operation (CO) mode, the scanner stops when it detects a signal, and after a factory preset time with no signal it resumes scanning.

**Search Operation**

In Search Operation (SE) mode, the scanner stops when it detects a signal.

To resume scanning you must press and hold the **[SCAN]** key again.

**Scanning a Frequency Range (VFO Mode)**

The BAOFENG Radio can scan the entire selected frequency range in a Band in increments of the saved step settings saved in the Setting Menu number 1 Step. The increment is in ranges from 2.5 kHz to 50 kHz depending on what value you have saved.

**Setting scanning range**

1. Press and Hold **[SCAN]** for about 2 seconds.
2. The Radio will begin to scan the entire frequency range for the band selected (VHF or UHF).

### Scanning Your Selected Channels (Channel Mode)

The BAOFENG Radio can scan your saved programmed memory channels.

#### Scanning channels

1. Press and Hold SCAN for about 2 seconds to start scanning.
2. All saved channels will be scanned.

### Chapter 6. - Dual Watch

In certain situations, the ability to monitor two channels simultaneously can be a valuable asset.

The BAOFENG Radio features Dual Watch functionality with the ability to scans between two frequencies at a fixed interval and to option to lock the transmit frequency to one of the two channels, A or B, being monitored.

#### Enabling or disabling Dual Watch mode

1. Press the **MENU** key to enter the menu
2. Enter **788** on the numeric keypad to get to Dual Watch.
3. Press **MENU** to select.
4. Use the **▲** and **▼** keys to enable or disable.
5. Press the **MENU** key to confirm.
6. Press the **EXIT** key to exit the menu.

Due to the way the BAOFENG Radio is constructed, whenever one of the A or B Frequencies, (VFO/MR) goes active, it will default to transmit on that channel. This behavior can be inconvenient, especially when monitoring a frequency, you should not transmit on. There is a menu option available to lock the transmitter to either the A or B channel.

#### Locking the Dual Watch transmit channel

1. Press the **MENU** key to enter the menu.
2. Enter **888** on the numeric keypad to get to the TDR-AB menu item.
3. Press **MENU** to select.
4. Use the **▲** and **▼** keys to select A (upper) or B (lower) display channel.

5. Press the **MENU** key to confirm.
6. Press the **EXIT** key to exit the menu.



If you want to momentarily override the lock without having to set the menu option to OFF, you can do so by pressing the A/B key an instant before pressing the PTT.

### Chapter 7. - DTMF

DTMF (Dual-Tone Multi-Frequency) is an in-band signaling method using dual sinusoidal signals for any given code. Originally developed for telephony systems, it has proved a very versatile tool in many other areas. In two-way radio systems, DTMF is most commonly used for automation systems and remote control. A common example would be in amateur radio repeaters where some repeaters are activated by sending out a DTMF sequence (usually a simple single-digit sequence).

#### DTMF frequencies and corresponding codes

697 Hz	1	2	3	1633 Hz
770 Hz	4	5	6	B
852 Hz	7	8	9	C
941 Hz	*	0	#	D
1209 Hz		1336 Hz	1477 Hz	

The BAOFENG Radio has a full implementation of DTMF, including the A, B, C and D codes. The numerical keys, as well as the **\*SCAN** and **#PTT** keys correspond to the matching DTMF codes as you would expect The A, B, C and D codes are accessible by pressing **MENU**, **▲**, and **EXIT** keys respectively.

To send DTMF codes, press the key(s) corresponding to the DTMF frequency(ies) you want to send while holding down the PTT key.



If you have the keypad lock enabled on your radio, you can still send DTMF tones without having to unlock your radio.

## Chapter 8. - Selective Calling

Sometimes when you're working with larger groups of people using the same channel, communication can get very crowded or disorderly. To minimize this problem, several methods of blocking out unwanted transmissions on your frequency have been developed. In general, there are two forms of selective calling in two-way radio systems: Group calling, and individual calling.

Group calling, as the name suggest, is a one-to-many form of communication. Every radio in your working group is configured the same way and any single radio will make contact with every other radio in the group.

The BAOFENG Radio features three different ways of group calling

- CTCSS
- DCS
- Tone-burst (1000Hz, 1450Hz, 1750Hz)

The BAOFENG Radio does not feature any form of individual calling.



Using these features does NOT mean that others won't be able to listen in on your transmissions. They only provide a method to filter out unwanted incoming transmissions. Any communications made while using these features will still be heard by anyone not employing filtering options of their own. Also, you cannot change the CTCSS or DCS settings while in memory (MR) mode.

CTCSS and 1750Hz tone-burst are also popular methods among amateur radio operators to open up repeaters.

### CTCSS

CTCSS is set with menus 11 R-CTCS and 13 T-CTCS.

For a complete list of available CTCSS codes and corresponding sub-tone frequencies, see Table C.2 "CTCSS Frequencies" in Appendix C, Technical specifications.

#### CTCSS setup how-to

1. Press the **MENU** key to enter the menu.
2. Enter **[STEP] 1 STEP** on the numeric keypad to get to receiver CTCSS.
3. Press **MENU** to select.
4. Enter desired CTCSS sub-tone frequency in hertz on the numeric keypad.

5. Press **MENU** to confirm and save.
6. Enter **[STEP] 3 SWF** on the numeric keypad to go to transmitter CTCSS.
7. Press **MENU** to select
8. Enter desired CTCSS sub-tone frequency in hertz on the numeric keypad. Make sure it's the same frequency as the one you entered for receiver CTCSS.
9. Press **MENU** to confirm and save.
10. Press **EXIT** to exit the menu system.

To turn CTCSS off, follow the same procedure but set it to off with the 0 SQL key instead of selecting a CTCSS sub-tone frequency.

For more operation details, see the section called "11- Receiver CTCSS" and the section called "13- Transmitter CTCSS" in Appendix B, Menu definitions.

### DCS

DCS is set with menus 10 R-DCS and 12 T-DCS.

For a complete list of available DCS codes, see Table C.1, "DCS Codes" in Appendix C, Technical specifications.

#### DCS setup how-to

1. Press the **MENU** key to enter the menu.
2. Enter **[STEP] 0 SWF** on the numeric keypad to get to receiver DCS.
3. Press **MENU** to select.
4. Enter desired DCS code on the numeric keypad.
5. Press **MENU** to confirm and save.
6. Enter **[STEP] 2 SWF** on the numeric keypad to go to transmitter DCS.
7. Press **MENU** to select.
8. Enter desired DCS code on the numeric keypad. Make sure it's the same code as the one you entered for receiver DCS.
9. Press **MENU** to confirm and save.

### 1000Hz, 1450Hz, 1750Hz Tone-burst

To send out a tone-burst, you simultaneously will press a key while holding down the PTT. No further configuration required to use this feature.

The following key combinations will transmit the according frequency tone burst below:

- PTT + **CALL** = Transmits 1000Hz Tone Burst  
 PTT + **MENU** = Transmits 1450Hz Tone Burst  
 PTT + **AV/B** = Transmits 1750Hz Tone Burst



If you have the keypad lock enabled on your radio, you can still send a 1750Hz tone without having to unlock your radio.

## Chapter 9. - Customization

The BAOFENG Radio allows for customization of both the power-on message (via computer link only), and the backlight color during the three states of the transceiver (Transmit, Receive and Standby).

### Display

The LCD on the BAOFENG Radio is backlit by multi-color LEDs, the color of which can be set in the menu system which a choice of three colors, blue, purple and orange.

To change the colors, follow these steps:

#### Changing backlight color

1. Press the **MENU** key to enter the menu.
2. Enter one of the following on your numeric keypad.
  - a. **2 7 0 7** **9 0 7** to change the standby WT-LED color.
  - b. **3 5 0 6** **0 5 0** to change the receive RX-LED color.
  - c. **3 5 0 6** **1 5 0 0** to change the transmit TX-LED color.
3. Press **MENU** key to select.

4. Use the **▲** and **▼** keys to pick the desired color.
5. Press **MENU** to confirm and save.
6. Press **EXIT** to exit the menu.

To change the duration the LCD backlight stays on, follow these steps:

#### Setting backlight time-out

1. Press the **MENU** key to enter the menu.
2. Enter **6 0 0 0** on your numeric keypad to come to backlight time out.
3. Press **MENU** key to select.
4. Use the **▲** and **▼** keys to pick the desired backlight timeout period in seconds. Press **MENU** to confirm and save
5. Press **EXIT** to exit the menu.
6. For details see the section called "29 WT-LED- Display backlight color, Standby" and onward in Appendix B, Menu definitions.

#### Setting the power-on-message via Baofeng computer software

NOTE – A programming cable is required for the following steps to connect the radio to a computer.

1. Click other in the computer software menu bar; a dialogue box titled "Other" will pop up.
2. In the box titled "Power On Message", there are two text fields representing the two lines on your radio LCD screen. Enter the desired text in the fields.
3. Click Write to write your changes to the radio.



Even though the software has eight (8) character wide text for the power-on message, be aware that the display on the GT-5R can only display a maximum of seven (7) characters.

Make sure the radio menu item 38 is set to MSG, otherwise your message won't be displayed. See Chapter 4 Working the menu system for details on how to navigate the menu.

Sometimes it takes the Baofeng software more than one try to connect to your radio. If you see a dialogue box popping up stating that you have a connection failure, close the dialogue box and click read or write again.

TIP - If you encounter issues programming your radio from the computer using the programming cable, try turning the radio volume knob to the highest volume level.

## Part III: Programming

### Chapter 10. - Preparation before Programming

#### Computer System Requirements

Operating System	Windows 98, Windows Me, Windows XP, Windows 7, Windows 8 and Windows 10.
Hard Disk Space	at least 50MB of available.
The Minimum Memory	64M

#### Programming Cable

USB programming cable - The driver needs to be installed before writing any frequencies. Find the corresponding driver of the system.

Click install and wait for the installation succeed.

If you are using a serial cable, it does not need to be installed with a driver. You can just plug in and use directly.

#### Software Download & Install

Turn on computer, check if your computer system meets the requirements.

Download the programming software on [baofengradio.com](http://baofengradio.com), install the programming software.

Connect your Walkie Talkie with Computer, USB (or serial) programming cable connects with the computer end.

Connect the other end of the cable with your walkie talkie.

When the both end shave been connected, turn on your radio. Make sure it has enough power during the programming procedure.

### Chapter 11. - Chirp Software Programming Process

1. Open the CHIRP software (Newest Version), click" Download From radio" under "Radio".



2. Select the corresponding cable driver port, and select Model "BAOFENG Radio" under, then click "OK" to read the radio.

3. And you will come to the page of Memories, in which you can adjust the limited parameters (Channel, TX Frequency, RX Frequency, CTCSS/DCS, High/Low Power, and Wide/Narrow Band, etc).

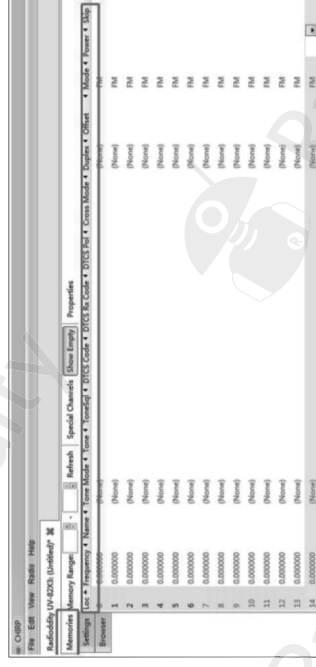

4. Then if you switch to the page of Settings, you can adjust the limited parameters (VOX Function, Squelch, Backlit, DTMF, FM Radio, Voice Prompt, Scanning, VFO Mode, etc).

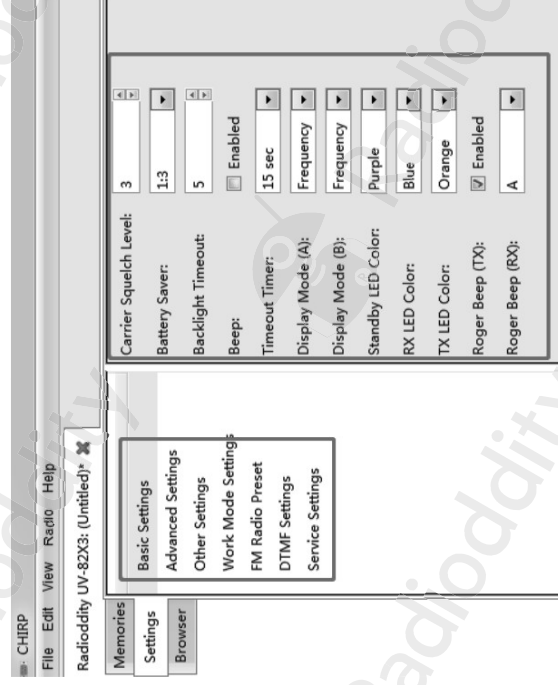

## Part IV: Advanced Features

### Chapter 12. - Channel Setting

#### Simplex Channels

The following steps assume that you're in Variable Frequency Oscillator (VFO) mode.

1. On the A (upper) seven character display use the numeric keypad to enter the simplex frequency (simplex means the transmit and receive frequencies are exactly the same).
2. Press the **MENU** key to enter the menu.
3. Enter **2** on the numerical keypad to get to the MEM-CH menu item.
4. Press **MENU** to select.
5. Use the **▲** and **▼** keys to select an empty memory channel, or enter it directly on the numeric keypad. If the characters "CH-" appear prepended to the channel number (000 to 127) that memory channel number already has saved data. Example CH-000, CH-079 or CH-127 means those channel numbers already have saved frequencies in them. If the displayed channel number is not prepended with the "CH-" characters that channel number is empty and you can use it to store your new simplex frequency from step 1 above.
6. Press the **MENU** key to confirm.
7. Press the **EXIT** key to exit the menu.

Switch to Memory Channel (MR) mode with the (VFO/MR) key to test your new simplex channel. If you would like to name your channel you will need to do that from a computer. More on that in the section called "Computer programming".

#### Duplex Channels

The following steps assume you're in Variable Frequency Oscillator (VFO) mode on the upper display. Duplex means the transmit and receive frequencies are different.

1. Save your receive frequency as you would a regular simplex channel, as described in the previous section. This saves your receive frequency to a channel number, example CH-123.
2. Exit the radio's settings menu by pressing the **EXIT** key; if you are still in the settings menu.
3. Now on the A (upper) seven character display use the numeric keypad to enter your transmit frequency.

4. Press the **#->** key momentarily to get into reverse mode, note the R icon above the frequency you entered on the radio's A (upper) seven character display.
5. Press the **[MENU]** key to enter the menu.
6. Enter **[2] [PR]** **[7] [DR]** on the numerical keypad to get to the MEM-CH menu item.
7. Press **[MENU]** to select.
8. Use the **[<]** and **[>]** keys to select, for example, CH-123 or enter 123 directly on the numerical keypad.
9. Press the **[MENU]** key to confirm.
10. Press the **[EXIT]** key to exit the menu.

Switch to Memory Channel (MR) mode with the (VFO/MR) key to test your new duplex channel. The receive frequency will be displayed for CH-123 and when you press the transmit button the transmit frequency will be displayed for CH-123. If you would like to name your channel you will need to do that from a computer. More on that in the section called "Computer programming".

### Computer Programming

The Radio kit does not include a programming cable. To attain a PC cable please visit <https://www.baofeng.com/> Download programming software at <https://www.baofengradio.com/pages/download> CHIRP is also another good alternative free programming software for non-commercial use. More information can be found here: <https://chirp.danplanet.com/projects/chirp/wiki/Home> CHIRP is supported on Windows, Apple Mac and Linux computers.

### Chapter 13. - Repeaters

A radio repeater is an automated transceiver in a fixed location. Usually mounted high up on hilltops or on tall buildings, but sometimes they operate within buildings for internal use. A repeater takes one signal and relays it, usually after amplifying it by orders of magnitude. This can be very handy, as this enables you to use a small low powered handheld two-way transceiver such as the BAOFENG Radio to reach great distances.

Whether you're a commercial (business or government) user or an amateur radio operator, chances are you'll deal with a repeater system sooner or later. To find out what settings to use to use your local repeater, ask your employer or someone at your local amateur radio organization for details.

A common type of repeater is the duplex repeater. In a duplex repeater system, the repeater transmits and receives simultaneously, but on different frequencies. To utilize this type of repeater, your radio has to be capable of transmitting and receiving on different frequencies on the same memory channel. How you use this kind of repeater is by setting the receive frequency of your radio to the output frequency of the repeater, and the transmit frequency of your radio to the input frequency of the repeater. Often times, the transmit frequency to use isn't explicitly stated, but rather an offset relative your receive frequency is specified. This is conveniently enough also how the BAOFENG Radio natively handles repeater set up in VFO, by specifying offset rather than transmit frequency.



This is might cause confusion because many expect this to be true globally when it isn't.

Menu item number 25 SFT-D and 26 OFFSET only function in Variable Frequency Oscillator (VFO) mode.

Memory Channel (MR) mode uses and stores the RX frequency and the TX frequency separately in the same memory channel only and does not save the SFT-D or OFFSET setting. SFT-D and OFFSET don't have to be set when using Memory Channel (MR) mode or they can even be set completely wrong and a working repeater channel can be created.

It is convenient to use SFT-D and OFFSET with 'reverse' mode to determine the TX frequency to be stored in a channel, but they are otherwise unused for Memory Channel (MR) mode.

The following instructions assume that you know what transmit and receive frequencies your repeater employs, and that you're authorized or licensed to use it.

#### Repeater setup

1. Set the radio to Frequency Variable Frequency Oscillator (VFO) mode with the **[VFO/MR]** key.
2. Enter the repeater's output (your receiving) frequency by either using the **[<]** and **[>]** Keys, or entering it directly on the numerical keypad.
3. Press the **[MENU]** key to enter the menu.
4. Enter on the **[2] [PR]** **[6] [SR]** on the numeric keypad to get to frequency OFFSET menu setting.
5. Press **[MENU]** key to select.
6. Use the **[<]** and **[>]** keys and numeric keypad to enter the specified frequency offset. See the section called "26 OFFSET-Frequency shift amount" for details.
7. Press **[MENU]** to confirm and save.
8. Enter **[2] [PR]** **[5] [MR]** on the numeric keypad to get to the SFT-D - Offset Frequency Shift Direction menu setting.
9. Use the **[<]** and **[>]** keys to select +(positive) or-(negative) offset.
10. Press **[MENU]** to firm and save.

11. Optional:
- Save to memory, see the section called "Manual programming" for details.
  - Set up CTCSS; see the section called "CTCSS" for details.
12. Press **EXIT** to exit the menu.

If everything went well, you should be able to make a test call through the repeater. If you're experiencing problems making a connection to the repeater, check your setting and/or go through the procedure again. Certain Amateur Radio repeaters (especially in Europe) use a 1750Hz tone burst to open up the repeater. To see how this is done with the BAOFENG Radio, see the section called "1750Hz Tone-burst". If you're still unable to make a connection, contact the person in charge of the radio system with your employer or your local amateur radio club, as the case may be.



If you for some reason want to listen to the repeater's input frequency instead, press **\*5230** momentarily and you'll reverse your transmit and receive frequencies.

This is indicated in the LCD on the radio with an R icon in the top row of the LCD display now, next to the + and/or - icons indicating an offset direction has been set.

## Chapter 14. - Application Specific Setup

### Commercial Radio Setup

Follow these instructions to set your radio to Narrowband mode:

This section is only true for VFO mode.

WN is settable on a per channel basis and has to be set prior to storing a channel. Once a channel has been programmed, the channel must be deleted and reprogrammed to change the WN setting.

- Press the **(VFO/WR)** key to enter Variable Frequency Oscillator (VFO) mode.
- Press the **(MENU)** key to enter the menu.
- Enter **5 (WN)** on the numerical keypad to get to the WN (Wide/Narrow) menu setting.
- Press **(MENU)** to select.
- Use the **(←)** and **(→)** keys to select between Wide and Narrow ("Nar").

- Press **(MENU)** to confirm and save.
- Press **EXIT** to exit the menu.

If your employer has a dispatch system that requires your radio to identify via ANI, please see Chapter 12, Automatic Number Identification for detailed instructions on how to set that up on your radio via computer with a programming cable.

To find out what other channels and features needed, please contact your employer.

### Amateur Radio Setup

In contrast with Commercial radio operators, who often need very specific requirements to be compatible with a very specific radio implementation, Amateur radio operators tend to need the broadest possible settings in order to be compatible with as many systems as possible. This basically implies turning all the fancy features that you typically might need for a commercial setup off.

In a typical Amateur radio setup the following settings would be recommended:

- Set bandwidth to Wide (menu item 5).
- Turn DCS and CTCSS off (menu items 10 through 13).
- Turn ANI, DTMFST, S-CODE, PTT-ID settings OFF and PTT-LT to Oms (menu items 15 through 17 and 19 through 20 respectively).
- Turn off the Squelch Tail Elimination (STE) , Repeater Squelch Tail Elimination RP-STE and Delay Tail Tone of Repeater RPT-RL features (menu items 35 through 37).
- Turn Roger beep (ROGER) off (menu item 39).

For further information see Appendix B, Menu definitions and Chapter4, Working the menu system.

## Part V: Appendix

## Appendix A. - Troubleshooting

Symptom	Possible	Solution
The radio won't power ON	The battery is too low. The battery isn't correctly installed.	Change or recharge the battery. Remove the battery and reinstall it.
The battery dies quickly	The battery is dead. The battery isn't fully charged.	Purchase a new battery. Recharge the battery.
The LED indicates reception, but the speaker is silent.	Volume is too low. CTCSS or DCS enabled	Turn up the volume. Change your CTCSS or DCS to match those of the radio or repeater you're trying to communicate with. Turn CTCSS or DCS off.
Others can't hear my transmission.	Their CTCSS or DCS settings don't match yours. You're too far apart.	Change your CTCSS or DCS settings to match your peers. Move in closer.
The radio transmits without touching the PTT.	The VOX is enabled. VOX sensitivity is too high.	Turn VOX off. Turn down VOX sensitivity.

## Appendix B. - Menu Definitions

See Chapter4, Working the menu system for more info about using menu-system.

Menu	Name (Full Name)	Setting	Description
0	SQL - Squelch Level	[0-9] Setting the squelch to 0 will open up the squelch entirely.	Squelch silences the receiver when there is no signal. Sensitivity can be varied from .1 to .3 mV on UHF Sensitivity can be varied from .1 to.2 mV on VHF
1	STEP - Frequency Step	2.5K[0]   5.0K[1]   6.25K[2]   10.0K[3]   12.5K[4]   20.0K[5]   25.0K[6]   50.QK [7]	Selects the amount of frequency change in VFO/Frequency mode when scanning or pressing the <b>[F1]</b> and <b>[F2]</b> keys.
2	TXP - Transmit Power	HIGH [0]   LOW [1]	Selects between HIGH and LOW transmitter power when in Variable Frequency Oscillator (VFO) mode. Use the minimum transmitter power necessary to carry out the desired communications.
3	SAVE - Battery Save	OFF [0]   1   2   3   4	Selects the ratio of sleep cycles to awake cycles (1:1,2:1,3:1,4:1). The higher the number the longer the battery lasts. The higher number increases the RX sleep cycle, but you may miss the first few syllables before the RX opens.
4	VOX-Voice	OFF [0]   1   2   3   4   5   6   7	When enabled it is not necessary to push the <b>[PTT]</b> button on the transceiver. Adjust the gain level to an appropriate sensitivity to allow smooth transmission.

Menu	Name (Full Name)	Setting	Description
5	WN – Wide band Narrow band	WIDE [0]   NARR [1]	Wideband (25 kHz bandwidth) or Narrow band (12.5 kHz band-width).
6	6 ABR - Display Illumination Time	OFF [0]   X   2   3   4   5   6   7   S   9   10	Time-out for the LCD backlight. (seconds)
7	TDR - Dual Watch, Dual Reception	OFF [0]   ON [1]	Monitor [A] and [B] at the same time. The display with the most recent activity will be switched to automatically.
8	BEEP - Keypad Beep	OFF [0]   ON [1]	Allows audible confirmation of a key press.
9	TOT - Transmission Time-out-Timer	15[0]-600[39] in 15 second steps (TIMEOUT-15)/15=[n]	This feature provides a safety switch that limits transmission time to a programmed value. This will promote battery conservation by not allowing you to make excessively long transmission, and in the event of a stuck PTT button it can prevent interference to other users as well as preventing battery depletion.
10	R-DCS-Receiver DCS	OFF[0] see DCS Table in Appendix C	Mutes the speaker of the transceiver in the absence of a specific low-level digital signal. If the station you are listening to does not transmit this specific signal, you will not hear anything.

Menu	Name (Full Name)	Setting	Description
11	R-CTCS - Receiver CTCSS	OFF[0] see CTCSS Table in Appendix C	Mutes the speaker of the transceiver in the absence of a specific and continuous sub-audible signal. If the station you are listening to does not transmit this specific and continuous signal, you will not hear anything.
12	T-DCS-Transmitter DCS	OFF[0] see DCS Table in Appendix C	Transmits a specific low-level digital signal to unlock the squelch of a distant receiver (usually a repeater).
13	T-CTCS-Transmitter CTCSS	OFF[0] see CTCSS Table in Appendix C	Transmits a specific and continuous sub-audible signal to unlock the squelch of a distant receiver (usually a repeater).
14	VOICE- Voice Prompt	OFF[0]   ENG [1]   CHI [2]	Sets the radio's voice prompts to the language set when pressing a button.
15	ANH-ID-Automatic Number ID		Displays the ANI code which has set by computer software. This menu cannot be used to change it. The ANI-ID is sent when the alarm is activated and menu 32=CODE.
16	DTMFST-DTMF-Side Tone of Transmit code	OFF [0]; No DTMF Side Tones are heard DT-ST [2]; Side Tones are heard only from automatically keyed DTMF codes DT+ANI [3]; All DTMF Side Tones are heard	Determines when DTMF Side Tones can be heard from the transceiver speaker.

Menu	Name (Full Name)	Setting	Description
17	S-CODE Signal Code	1[0] 2[1] 3[2] 4[3] 5[4] 6[5]   7[6] 8[9] 9[8] 10[9] 11[10]   12[11] 13[12] 14[13] 15[14]	Selects 1 of 15 DTMF codes. The DTMF codes are programmed with computer software and are up to 5 characters/digits each.
18	SC-REV-Scanner Resume Method	To [0]: Time Operation-scanning will resume after a fixed time has passed CO [1]: Carrier Operation-scanning will resume after the signal received disappears SE [2]: Search Operation-scanning will not resume automatically	Scanning Resume Method.
19	PTT-ID – When to send the Push-To-Talk (PTT-ID)	OFF [0]: No ID is sent BOT [1]: The selected S-CODE is sent at the beginning EOT [2]: The selected S-CODE is sent at the beginning and ending	When to send PTT-ID The codes are sent either at the beginning or ending of a transmission.
20	PTT-LT-Signal Code sending delay	0-50ms	PTT-ID Delay (milliseconds)

Menu	Name (Full Name)	Setting	Description
21	MDF-A-Channel Mode A Upper LCD Display	CH [0]: Displays the channel number NAME [1]: Display the channel name FREQ [2]: Display programmed Frequency	[A] MR/Channel Mode Display Format Note: Names must be entered using computer software.
22	MDF-B-Channel Mode B Lower LCD Display	CH [0]: Displays the channel number NAME [1]: Display the channel name FREQ [2]: Display programmed Frequency	[B] MR/Channel Mode Display Format Note: Names must be entered using computer software.
23	BCL- Busy Channel Lock-out	OFF [0]   ON [1]	Disables the [PTT] button on a channel that is already in use. The transceiver will sound a beep tone and will not transmit if the [PTT] button is pressed when a channel is already in use.
24	AUTOLK	OFF [0]   ON [1]	When OFF the numeric keypad is not automatically locked after 10 seconds. When ON the numeric keypad is locked after 10 seconds. NOTE - To unlock the numeric keypad press and hold the #/Lock button on the numeric keypad.

Menu	Name (Full Name)	Setting	Description
25	SFT-D - Frequency Shift Direction	OFF [0]; TX = RX (simplex) +[1]: TX will be shifted higher in frequency than RX frequency. -[2]: TX will be shifted lower in frequency than RX frequency.	Enables access of repeaters in VFO/ Frequency Mode.
26	OFFSET - Frequency Shift amount	00,000-69,990 in 10 kHz steps	Specifies the difference between the TX and RX frequencies. The RX frequency is the base and the amount set here will be the offset frequency for the TX frequency.
27	MEM-CH - Store a Memory Channel	000-127	This menu is used to either create new or modify existing channels (0 through 127) so that they can be accessed from MR/Channel Mode.
28	DEL-CH-Delete a memory channel	000-127	This menu is used to delete the programmed information from the specified channel (0 through 127) so that it can either be programmed again or be left empty.
29	WT-LED - Display backlight color, Wait/Standby	OFF [0]   BLUE [1]   ORANGE [2]   PURPLE [3]	Default: PURPLE
30	RX-LED - Display backlight color-Receive	OFF [0]   BLUE [1]   ORANGE [2]   PURPLE [3]	Default: BLUE

Menu	Name (Full Name)	Setting	Description
31	TX-LED - Display backlight color-Transmit	OFF [0]   BLUE [1]   ORANGE [2]   PURPLE [3]	Default: ORANGE
32	AL-MOD - Alarm Mode	SITE [0]: Sounds alarm through your radio speaker only TONE [1]: Transmits a cycling tone over-the-air CODE [2]: Transmits '119' (911 in reverse?) followed by the ANI code over-the-air	SITE: Sounds alarm through your radio speaker only TONE: Transmits a cycling tone over-the-air CODE: Transmits '119' (911 in reverse?) followed by the ANI code programmed by computer software over-the-air
33	BAND	UHF or VHF	Displays the Band of the current displayed frequency on the Upper A or Lower B LCD display.
34	TDR-AB - Transmit selection while in Dual Watch mode	OFF [0]   A [1]   B [2]	When enabled, transmit priority is set to selected LCD display A or B once the received signal in the other A or B display disappears.
35	STE - Squelch Tail Elimination	OFF [0]   ON [1]	This function is used eliminate squelch tail noise between Baofeng handhelds that are communicating directly (no repeater). Reception of a 55 Hz or 134.4 Hz tone burst mutes the audio long enough to prevent hearing any squelch tail noise.

Menu	Name (Full Name)	Setting	Description
36	RP-STE - Squelch Tail Elimination	OFF [0]   1 - 10	This function is used eliminate squelch tail noise when communicating through a repeater.
37	RPT-RL - Delay the squelch tail of repeater	OFF [0]   1 - 10	Delay the Tail Tone of Repeater (X100 milliseconds).
38	PONMSG - Power On Message	FULL [0]: Performs an LCD screen test at power-on MSG [1]: Displays a 2-line power-on message	Controls the behavior of the display when the transceiver is turned on. When set to MSG [1] the computer software programmed message is displayed up to 2 lines and at 6 characters per line.
39	ROGER- Roger Beep	OFF [0]   ON [1]	Sends an end-of-transmission tone to indicate to the other stations that the transmission has ended.
40	RESET - Restore defaults	VFO [0]   ALL [1]	Resets the radio to factory defaults, with some exceptions.

## Appendix C. - Technical Specifications

### General

#### General Specifications

Specification	Value
Frequency Range (MHz)	144-148 (Rx only)
Memory channels	420-450MHz
Frequency stability	128 total (0-127)
Frequency step (kHz)	2.5ppm
Antenna impedance	2.5K/5.0K/6.25K/10.0K/12.5K/20.0K/25.0K/50.0K
Operating temperature	50 Ohm
Supply voltage	-20°C to +60°C
Consumption	7.4V
Mode of operation	≤75mA (standby)
Duty cycle	380mA (reception)
Dimensions(mm)	≤1.4A(transmission)
Weight (g)	Simplex or semi-duplex
	03/03/54 min. (Rx/Tx/ Standby)
	58X110X32
	214

**Transmitter  
Transmitter Specifications**

Specification	Value
RF power (Watts)	5W/1W
Emission class	16K#F3E(wide band)
	1K#F3E (narrowband)
Maximum deviation(kHz)	±±5.0 (wide band)
	±±2.5 (narrowband)
Spurious emissions (dB)	<-60dB

**Receiver  
Receiver Specifications**

Specification	Value
Receiver sensitivity	0.2µV (a t 12dB SINAD)
Intermodulation	60dB
Audio Output	1000mW
Adjacent channel selectivity	65/60dB

**DCS Table  
DCS Codes**

Number	Code	Number	Code	Number	Code	Number	Code
001	D023N	002	D025N	003	D026N	004	D031N
005	D032N	006	D036N	007	D043N	008	D047N
009	D051N	010	D053N	011	D054N	012	D065N
013	D071N	014	D072N	015	D073N	016	D074N
017	D114N	018	D115N	019	D116N	020	D122N
021	D125N	022	D131N	023	D132N	024	D134N
025	D143N	026	D145N	027	D152N	028	D155N
029	D156N	030	D162N	031	D165N	032	D172N
033	D174N	034	D205N	035	D212N	036	D223N
037	D225N	038	D226N	039	D243N	040	D244N
041	D245N	042	D246N	043	D251N	044	D252N
045	D255N	046	D261N	047	D263N	048	D265N
049	D266N	050	D271N	051	D274N	052	D306N
053	D311N	054	D315N	055	D325N	056	D331N
057	D332N	058	D343N	059	D346N	060	D351N
061	D356N	062	D364N	063	D365N	064	D371N
065	D411N	066	D412N	067	D413N	068	D423N
069	D431N	070	D432N	071	D445N	072	D446N
073	D452N	074	D454N	075	D455N	076	D462N
077	D464N	078	D465N	079	D466N	080	D503N
081	D506N	082	D516N	083	D523N	084	D526N
085	D532N	086	D546N	087	D565N	088	D606N
089	D612N	090	D624N	091	D627N	092	D631N

Number	Code	Number	Code	Number	Code	Number	Code
091	D627N	092	D631N	093	D632N	094	D645N
094	D645N	095	D654N	096	D662N	094	D645N
097	D664N	098	D703N	099	D718N	100	D723N
101	D731N	102	D732N	103	D734N	104	D743N
105	D754N	106	D0231	107	D0251	108	D0261
109	D0311	110	D0321	111	D0361	112	D0431
113	D0471	114	D0511	115	D0531	116	D0541
117	D0651	118	D0711	119	D0721	120	D0731
121	D0741	122	D1141	123	D1151	124	D1161
125	D1221	126	D1251	127	D1311	128	D1321
129	D1341	130	D1431	131	D1451	132	D1521
133	D1551	134	D1561	135	D1621	136	D1651
*137	D1721	D1741	D2051	D2121	D2231	D2251	D2261
D2431	D2441	D2451	D2461	D2511	D2521	D2551	D2611
D2631	D2661	D2711	D2741	D3061	D3111	D3151	D3251
D3311	D3321	D3431	D3461	D3511	D3561	D3641	D3651
D3711	D4111	D4121	D4131	D4231	D4311	D4321	D4451
D4461	D4521	D4541	D4551	D4621	D4641	D4651	D4661
D5031	D5061	D5161	D5231	D5261	D5321	D5461	D5651
D6061	D6121	D6241	D6271	D6311	D6321	D6451	D6541
D6621	D6641	D7031	D7121	D7231	D7311	D7321	D7341
D7431	D7541						

 \*After DCS Number Shortcut 137, in order to navigate through the subsequent codes manually key in shortcut 137 and then use the arrow keys to navigate to the DCS tone above shortcut 136 required manually.

**CTCSS Table**  
**CTCSS Frequencies**

Number	Frequency	Number	Frequency	Number	Frequency	Number	Frequency
01	67.0	02	69.3	03	71.9	04	74.4
05	77.0	06	79.7	07	82.5	08	85.4
09	88.5	10	91.5	11	94.8	12	97.4
13	100.0	14	103.5	15	107.2	16	110.9
17	114.8	18	118.8	19	123	20	127.3
21	131.8	22	136.5	23	141.3	24	146.2
25	151.4	26	156.7	27	162.2	28	167.3
29	165.5	30	171.3	31	177.0	32	182.5
33	177.8	34	183.5	35	189.3	36	194.8
37	189.9	38	195.7	39	201.3	40	206.5
41	203.5	42	209.3	43	215.0	44	220.7
45	225.7	46	231.5	47	237.3	48	243.0
49	250.3	50	256.1				